

Sliding lock adjustment system

VDS

Sliding lock for oblong hole

- Clamping lock for oblong hole

- Materials:

High pressure die-cast zinc body, chrome-plated
Button in black or orange thermoplastic polyamide
Stainless steel tightening pins and wedges POM
plunger

- Temperature of use: Max. 90°C

Advantages

- Allows locking or unlocking without tools and without screws by simply turning the button
- Saves time by avoiding the handling of tools.

Accessories

- Blocking wedge VDS-CB
- Can be used with a ruler with groove (not supplied).

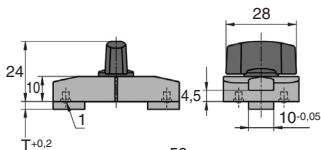

Mounting dimensions of the counterpart

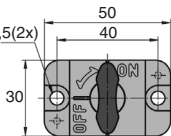
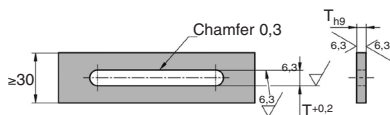

Offset with static load in one direction

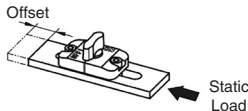
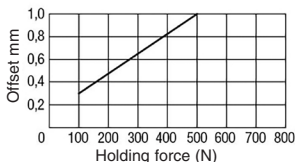

Forces apply to steel or stainless steel plates

DISCOUNTS

Qty	1+	4+	8+
Disc.	List	-5%	On request

Part number	T1	T2	Holding force (N)	Stock*	Price each 1 to 3
Black button					
VDS50-3/N	3	3	500	-	72,47 €
VDS50-6/N	6	6	500	-	72,47 €
Orange button					
VDS50-3/O	3	3	500	-	72,47 €
VDS50-6/O	6	6	500	-	72,47 €

*Depending on availability - Dimensions in mm

Sliding lock adjustment system

Blocking wedge for sliding lock for oblong hole VDS5CB

- **Blocking wedge necessary for sliding locks for oblong holes with plates thicker than 3mm or 6mm.**

- **Materials:**
Stainless steel natural finish

Accessories

- Sliding lock VDS

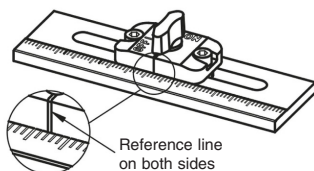
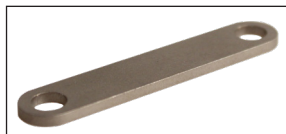

Application example

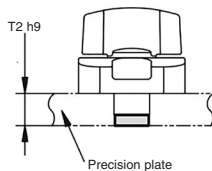
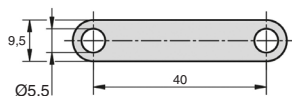
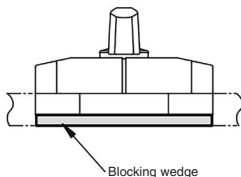

Sliding lock for oblong hole	Suitable blocking wedge	Precision plate T2 (mm)
VDS50-3/N	-	3 _{-0,25}
VDS50-3/O	VDS50-2/CB	5 _{-0,3}
	-	6 _{-0,3}
VDS50-6/N	VDS50-2/CB	8 _{-0,36}
VDS50-6/O	VDS50-3/CB	9 _{-0,36}

DISCOUNTS

Qty	1+	4+	8+
Disc.	List	-5%	On request

Part number	T	Stock*	Price each
VDS50-2/CB	2	-	6,30 €
VDS50-3/CB	3	-	6,79 €

*Depending on availability - Dimensions in mm

Sliding lock adjustment system

VDSQ Sliding lock for square profile

- Clamping lock for square profile

- Materials:

High pressure die-cast zinc body, chrome-plated
Button in black or orange thermoplastic polyamide
Stainless steel locking pins and wedges
Phosphated bronze leaf spring

- Temperature of use: Max. 90°C



Advantages

- Allows locking or unlocking without tools and without screws by simply turning the button
- Saves time by avoiding the handling of tools.

Accessories

- Blocking wedge VDSQ-CB
- Can be used with a ruler with groove (not supplied).

Mounting dimensions of the square counterpart

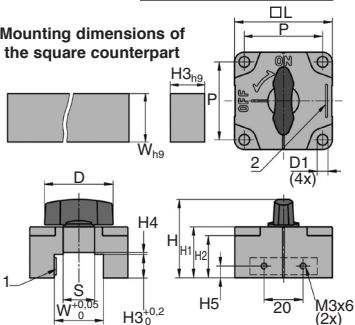

Offset with static load in one direction

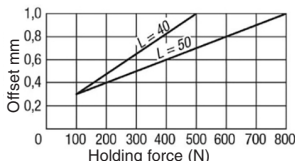

Forces apply to steel or stainless steel square elements

DISCOUNTS

Qty	1+	4+	8+
Disc.	List	-5%	On request

Part number	L	ØD	ØD1	H	H1	H2	H3	H4	H5	P	W	S	Holding force (N)	Stock*	Price each
															1 to 3
Black button															
VDSQ40-12-12/N	40	28	4,5	36	22	18,5	12	-	6,0	32	12	-	500	-	83,48 €
VDSQ40-16-16/N	40	28	4,5	40	26	22,5	16	-	8,0	32	16	-	500	-	83,48 €
VDSQ50-9-25/N	50	35	5,5	37	23	18,5	9	1	4,5	40	25	16	800	-	89,79 €
VDSQ50-12-25/N	50	35	5,5	40	26	21,5	12	1	6,0	40	25	16	800	-	89,79 €
VDSQ50-12-32/N	50	35	5,5	40	26	21,5	12	1	6,0	40	32	16	800	-	89,79 €
VDSQ50-16-32/N	50	35	5,5	44	30	25,5	16	1	8,0	40	32	16	800	-	89,79 €
Orange button															
VDSQ40-12-12/O	40	28	4,5	36	22	18,5	12	-	6,0	32	12	-	500	-	83,48 €
VDSQ40-16-16/O	40	28	4,5	40	26	22,5	16	-	8,0	32	16	-	500	-	83,48 €
VDSQ50-9-25/O	50	35	5,5	37	23	18,5	9	1	4,5	40	25	16	800	-	89,79 €
VDSQ50-12-25/O	50	35	5,5	40	26	21,5	12	1	6,0	40	25	16	800	-	89,79 €
VDSQ50-12-32/O	50	35	5,5	40	26	21,5	12	1	6,0	40	32	16	800	-	89,79 €
VDSQ50-16-32/O	50	35	5,5	44	30	25,5	16	1	8,0	40	32	16	800	-	89,79 €

*Depending on availability - Dimensions in mm

Sliding lock adjustment system

Blocking wedge

VDSQCB

- **Blocking wedge**
- A locking wedge is required for clamp bolts for square profile with a 3mm thick plate.
- They are used to move the clamping lock on a fixed square.
- Materials:
Stainless steel natural finish

Accessory

- Sliding clamping lock VDSQ

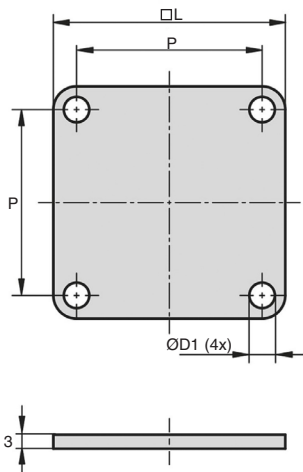
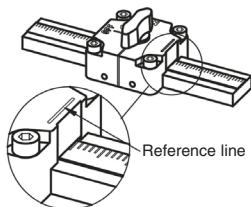
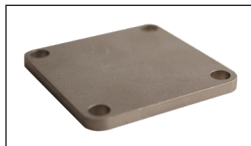

DISCOUNTS

Qty	1+	4+	8+
Disc.	List	-5%	on request

Part number	L	ØD1	P	Stock*	Price each 1 to 3
VDSQ40-32/CB	40	4,5	32	-	8,97 €
VDSQ50-40/CB	50	5,5	40	-	10,54 €

*Depending on availability - Dimensions in mm

Our other products



Connecting plate for T type timing belts, T5



Fastener for aluminium profile, Angular joint



Worm and wheel gear reducer, up to 118 Nm

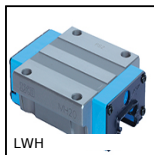

High rigidity linear slide, Chariot - from 9320 N to 71300 N



Cylindrical spacer, Thermoplastic



Stainless steel hexagonal headed thumb nut, Lobed handscrew



Worm and wheel set, Machined plastic (delrin)



Housing for open linear bearing, Opened - long

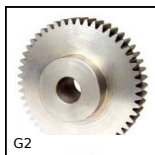

Steel spur gear, Steel 20NCD2

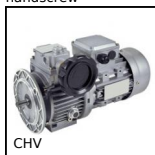

Mechanical speed variator, from 0,18 to 1,5kW



Latch, Spring loaded latch - stainless steel



Backlash free coupling Gerwah®, from 1.2 to 450Nm

Complementary products