

The Utilitrak® linear guide system is designed for applications where low cost, easy installation and minimal maintenance requirements are the primary design objectives.

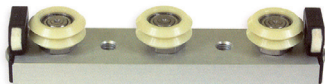

Designed primarily for transport type applications, Utilitrak® is intended for use where load capacity, stiffness, and positional accuracy are less demanding than machine tool applications. Utilitrak® offers a low cost alternative to recirculating ball guide technologies, which often require a considerable amount of surface preparation, adding significantly to the total installed cost.

**UTK- SW:** Hardened and ground steel channel with precision steel wheels.

**UTK- PW:** Aluminium alloy channel with polymer over-moulded wheels.

### Features and benefits

- Frictionless operation
- Low noise
- Smooth running
- High speed capacity
- Unlimited travel lengths
- High load capacity
- Resistant to contamination by dust

### Load Capacity

- The load capacity ratings in this guide are based on 100km of service life. As with any linear bearing technology, the choice of the size of the Utilitrak® track should be done conservatively. If the guide selection is such that load capacities are marginal, it may be appropriate to consider the next larger size.

### Lubrication

- The recirculating elements within DualVee® guide wheels are lubricated for life and sealed against the operating environment. The contact surfaces between the wheel and channel do however require lubrication to maximize the life and speed of the guide. All Utilitrak® carriages come complete with lubricators, consisting of an oil saturated felt pad within a housing. Lubricators should be periodically checked and re-oiled to ensure that a sufficient coating of lubricant is maintained on the channel guideway surfaces.

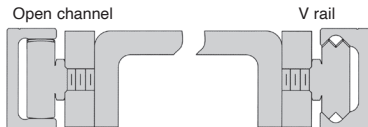

Mounting on open or V rail

- Used with UTK-PW Series V wheel carriage assemblies
- U shaped aluminium alloy (6063-T6) channel
- Lightweight
- Tolerance on length +/-2mm

### Option

- Increased length, max 3600mm

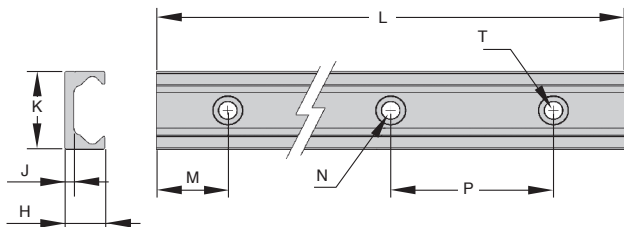

### DISCOUNTS

Qty	1+	2+	4+
Disc.	List	-10%	On request

Part number	H	J	K	L	M	N Ø x depth (counterbore)	T (Ø hole)	P	Rail weight (kg/m)	Carriage weight (g)	Stock*	Price each
UTK0-PWR	11,0	4,0	20	1000	20	8,3 x 3	4,8	80	0,30	46	-	100,47 €
UTK1-PWR	15,0	4,0	26	1000	20	9,8 x 2,8	5,8	80	0,50	92	✓	109,53 €
UTK2-PWR	19,7	4,5	40	1000	20	14,3 x 3	8,8	80	0,93	243	✓	159,98 €

\*Depending of availability - Dimensions in mm

- V style carriage assembly for UTK-PWR aluminium channel
- Light to medium duty transport applications
- Extremely low noise
- Lightweight and economical

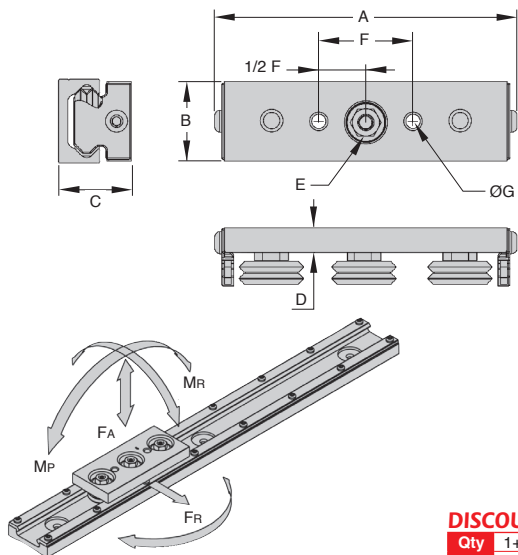
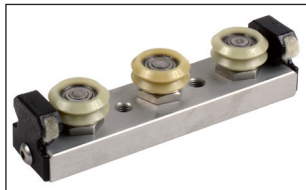

### DISCOUNTS

Qty	1+	2+	4+
Disc.	List	-10%	On request

Part number	E				Load capacity								Stock*	Price each	
	A	B	C	D	Socket size	F	ØG	Radial Fr (N)	Axial FA (N)	MP (Nm)	MY (Nm)	MR (Nm)			
UTK0-PWC	79,9	18	22,0	7,9	8	22	M4x0,7	55	88	3	1,5	1	130	-	181,46 €
UTK1-PWC	113,5	24	26,3	8,8	10	40	M6x1	110	155	8	3,0	2	200	✓	148,51 €
UTK2-PWC	144,2	38	35,0	11,8	13	45	M8x1,25	165	311	18	8,0	4	350	✓	168,31 €

\*Depending of availability - Dimensions in mm



- For use with UTK-PWCR roller carriages
- V shaped channel made from aluminium 6063-T6
- Lightweight
- Length may vary +/- 2mm

### Option

- Max rail length : 3600mm

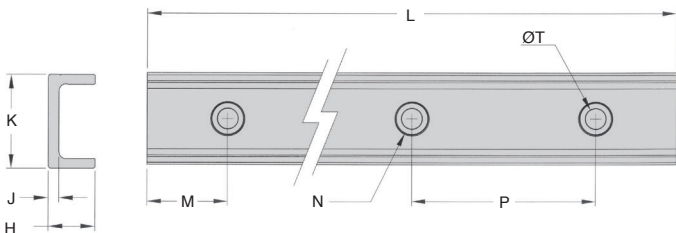

### DISCOUNTS

Qty	1+	2+	4+
Disc.	List	-10%	On request

Part number	H	J	K	L	M	Dia x depth (counterbore)	T (Ø hole)	P	Rail weight (kg/m)	Carriage weight (g)	Price each
UTK0-PWRR	11,0	4,0	20	1000	20	8,3 x 3	4,8	80	0,29	47	100,71 €
UTK1-PWRR	15,0	4,0	26	1000	20	9,8 x 2,8	5,8	80	0,43	94	109,79 €
UTK2-PWRR	19,7	4,5	40	1000	20	14,3 x 3	8,8	80	0,80	246	160,32 €

Dimensions in mm



# Utilitrak® 3 wheel carriage

roller

HEPCO

UTKPWCR

- Cam follower style carriage for use with UTK-PWRR aluminium channel
- Intended for radial loads only
- Reduced noise
- Light and economic

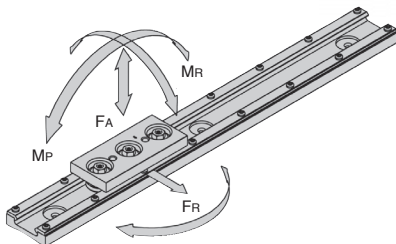
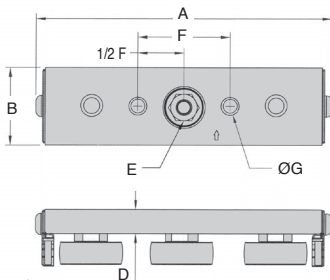
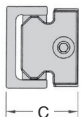
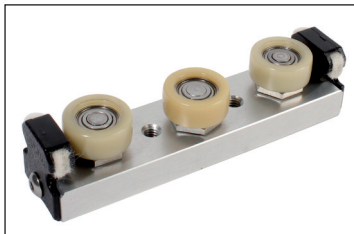

## DISCOUNTS

Qty	1+	2+	4+
Disc.	List	-10%	On request

Part number	A	B	C	D	E allen key	F	ØG	Admissible load					Price each	
								Fr (N)	FA (N)	Mp (Nm)	My (Nm)	Mr (Nm)		C
UTK0-PWCR	79,9	18	22,0-23,1	7,9	8	22	M4x0,7	55	0	0	1,5	0	130	181,96 €
UTK1-PWCR	113,5	24	25,3-27,6	8,8	10	40	M6x1	110	0	0	3,0	0	200	154,25 €
UTK2-PWCR	144,2	38	34,7-37,4	11,8	13	45	M8x1,25	165	0	0	8,0	0	350	168,72 €

Dimensions in mm

Fax: 0 825 88 6000 Service 0,15€/mln + prix appel

cial2@hpcurope.com

WEB  
04/2020

HPC

- Used with UTK-SWC Series V wheel carriage assemblies
- Carbon bearing steel with hardened steel raceways
- Running surface smooth to Ra 0.8µm
- Tolerance on length +/-2mm



### Option

- Increased length, max 3600mm

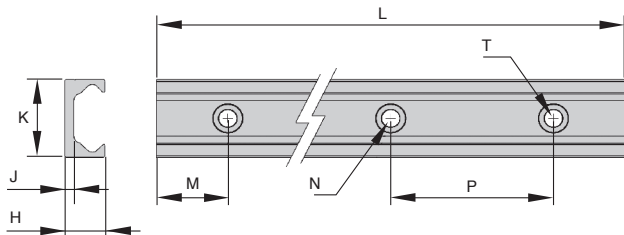

### DISCOUNTS

Qty	1+	2+	4+
Disc.	List -10%		On request

Part number	H	J	K	L	M	N Ø x depth (counterbore)	T (Ø hole)	P	Rail weight (kg/m)	Carriage weight (g)	Stock*	Price each
UTK1-SWR	15,0	4,0	26	1000	20	9,8 x 2,8	5,8	80	1,46	114	✓	265,96 €
UTK2-SWR	19,7	4,5	40	1000	20	14,3 x 3	8,8	80	2,70	330	-	340,52 €
UTK3-SWR	30,0	8,0	58	1000	20	14,3 x 5	8,8	80	5,91	943	-	504,66 €

\*Depending of availability - Dimensions in mm



# Utilitrak® 3 wheel carriage

## Precision steel wheels



## UTKswc

- Used with UTK-SWR Series V wheel carriage assemblies
- Suitable for medium/heavy loads
- Suitable for high speeds
- Smooth frictionless operation

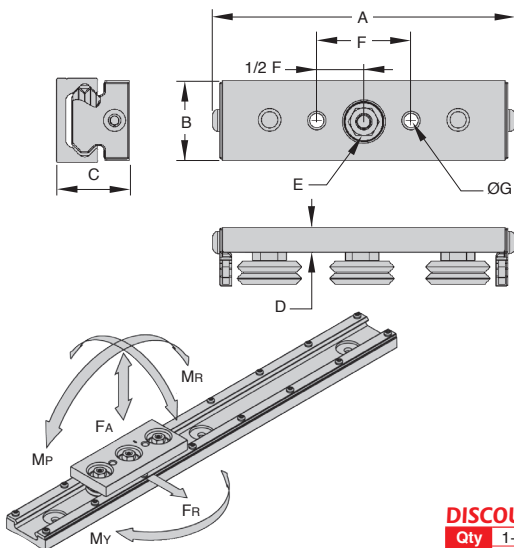

### DISCOUNTS

Qty	1+	2+	4+
Disc.	List	-10%	On request

Part number	E				Load capacity							Price each			
	A	B	C	D	Socket size	F	ØG	Radial Fr (N)	Axial FA (N)	Mp (Nm)	My (Nm)		Mr (Nm)		
UTK1-SWC	113,5	24	26,3	8,8	10	40	M6x1	2440	719	18	30,5	7,0	5600	✓	200,11 €
UTK2-SWC	144,2	38	35,0	11,8	13	45	M8x1,25	5300	1475	58	100,0	22,7	10200	-	243,27 €
UTK3-SWC	201,3	55	50,0	15,8	15	60	M10x1,5	11800	5100	229	346,0	118,0	21600	-	309,32 €

\*Depending of availability - Dimensions in mm



- For use with STK-PWCR roller carriages
- Carbon bearing steel with hardened steel raceways
- Smoothness Ra 0.8µm
- Length may vary +/- 2mm

### Option

- Max rail length : 3600mm

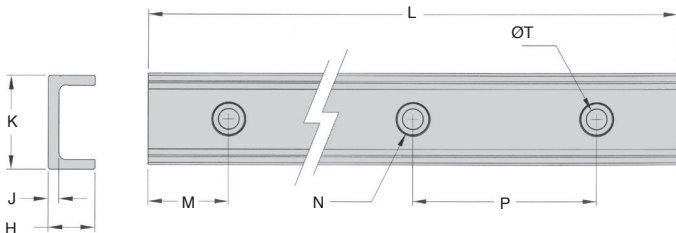

### DISCOUNTS

Qty	1+	2+	4+
Disc. List	-10%	On request	

Part number	H	J	K	L	M	Dia x depth (counterbore)	T (Ø hole)	P	Rail weight (kg/m)	Slide weight (g)	Price each
UTK1-SWRR	15,0	4,0	26	1000	20	9,8 x 2,8	5,8	80	1,33	121	266,56 €
UTK2-SWRR	19,7	4,5	40	1000	20	14,3 x 3	8,8	80	2,47	320	341,29 €
UTK3-SWRR	30,0	8,0	58	1000	20	14,3 x 5	8,8	80	5,36	910	505,79 €

Dimensions in mm





- Cam follower style carriage for use with UTK-SWRR steel channel
- Intended for radial loads only
- Suitable for higher speeds
- Smooth friction free operation

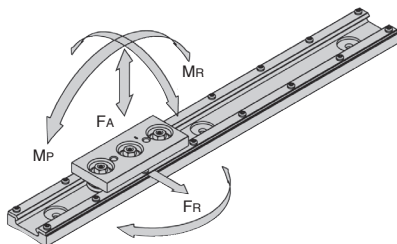
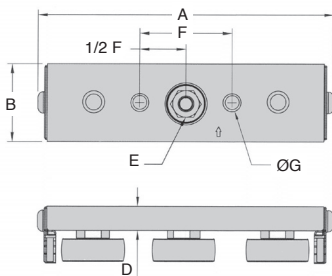
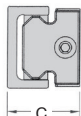
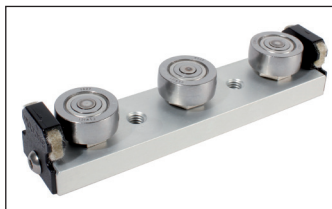

### DISCOUNTS

Qty	1+	2+	4+
Disc.	List	-10%	On request

Part number	A	B	C	D	E Allen key	F	ØG	Admissible load					Price each	
								FR (N)	FA (N)	MP (Nm)	MY (Nm)	MR (Nm)		
UTK1-SWCR	113,5	24	25,3-27,6	8,8	10	40	M6x1	2440	0	0	30,5	0	5600	192,58 €
UTK2-SWCR	144,2	38	34,7-37,4	11,8	13	45	M8x1,25	5300	0	0	100,0	0	10200	248,03 €
UTK3-SWCR	201,3	55	46,3-53,4	15,8	15	60	M10x1,5	11800	0	0	346,0	0	21600	309,32 €

Dimensions in mm

### Accuracy

- The accuracy of the Utilitrak® system is defined differently than typical recirculating ball guides. These are designed primarily for "high end" positioning applications, such as machine tool guideways, Cartesian coordinate robotics and precision XY inspection equipment. These guides are more rigidly defined in terms of the running parallelism of carriages to rail, and are measured as a function of rail length. Their higher cost can be attributed to the grinding and finishing operations necessary to achieve these tight tolerances.
- Utilitrak®, in contrast, has been developed for "lower end" transport applications. The definition of accuracy in this class of guide is independent of channel length, and is measured solely by the parallelism maintained between the critical channel surfaces, this does not vary by more than 0.05 mm over the entire length of the channel. As with any linear guide, installed accuracy is directly related to the straightness and flatness of the surface to which it is mounted. Because the guide will conform to the mounting surface, it is important for that surface to be more rigid than the Utilitrak® channel.

### Life expectancy

The sum of the applied loads divided by system load capacity should be less than or equal to 1:

$$LF = \frac{F_R}{F_R(\text{MAX})} + \frac{F_A}{F_A(\text{MAX})} + \frac{M_R}{M_R(\text{MAX})} + \frac{M_Y}{M_Y(\text{MAX})} + \frac{M_P}{M_P(\text{MAX})} \leq 1$$

The applied force on the system is equivalent to:

$$F = F_{R(\text{MAX})} * LF$$

Knowing the equivalent applied load, the system life can now be calculated:

$$L_{\text{km}} = 100 * \left( \frac{C}{F} * \frac{1}{f_c} \right)^3$$

$L_{\text{km}}$	= System life in kilometres
$C$	= System dynamic load rating
$F$	= Equivalent load
$f_c$	= Correction factor

### Correction factor table

Environmental factor	Correction value $f_c$
No shock or vibration, clean working environment, speed <1m/s	1,46
Light shocks or vibration, speed between 1m/s to 2m/s	1,85
Shocks, vibrations, harsh environment, speed >2m/s	3

## Our other products

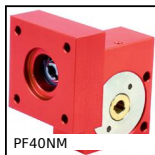

PF40NM  
Worm and wheel gear reducer, up to 18 Nm



CF  
Cam follower, Standard - steel



M0  
Worm and wheel set, Unhardened steel



F7-P-AM  
Multifunction display, Magnetic ring



RBS  
Dynamic washer DIN2093, Steel



CHAE4080PA  
Symmetrical decorative screwed hinge, Polyamide



RURt  
Swivel castor with central hole, Polyurethane - Aluminium rim (Free



M2  
Worm and wheel set, Unhardened steel



BAC105  
Storage bin, 8mm



PSG05  
Spur gear - precision range, Pre-hardened



PO  
Pull handle - Multi-sector, Tapped



RTL450  
Self-centering locking assembly, High torque

## Complementary products



UTKswr  
Utilitak® V rail, V rail