

# Sealed flange bearing unit for Food Industry

## SBFop

### With 4 fixing holes

- **Sealed bearing**
- Massive, without retention surface
- Resistant to frequent washing and detergents
- **Materials**
  - 316 stainless steel housing
  - 440 stainless steel bearing
  - Optical and detectable blue hygienic seals
- Complies with EHEDGE hygiene directives

**NEW !**

open



## Application

- For the highly challenging food and beverage industry

## Info

- Stainless steel bearings for the food and beverage industry are completely sealed units with an open or closed cover and a rear seal.

Blue foodgrade cover seal

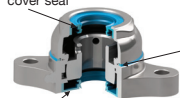

Blue foodgrade back seal



O-ring  
DHRGS foodgrade hygienic seal

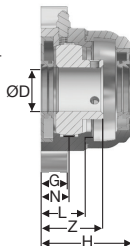
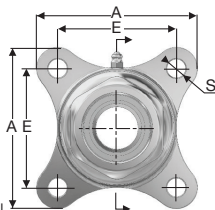

Type	SBF 204	SBF 205	SBF 206	SBF 207	SBF 208	SBF 209	SBF 210
of load (N)	15950	13000	18000	18500	19100	19350	19650

	15950	13000	18000	18500	19100	19350	19650
--	-------	-------	-------	-------	-------	-------	-------

	10250	12150	17700	18500	19250	19350	19620
--	-------	-------	-------	-------	-------	-------	-------

	3650	3350	3350	3520	3790	3850	3990
--	------	------	------	------	------	------	------

## DISCOUNTS

Qty	1+	4+	8+
Disc.	List	-5%	On request

Part Number	Diameter									Price each 1 to 3
	ØD	A	E	G	H	L	N	S	Z	
SBF204/OP	20	88	64	15	51,9	24	15	12	33,0	135,74 €
SBF205/OP	25	95	70	15	52,4	25	16	12	35,5	155,14 €
SBF206/OP	30	108	83	15	58,7	29	18	12	40,0	179,38 €
SBF207/OP	35	117	92	17	62,4	31	19	14	42,5	208,46 €
SBF208/OP	40	130	102	17	70,7	32	21	16	46,0	252,10 €
SBF209/OP	45	135	105	18	69,2	33	22	16	53,7	300,58 €
SBF210/OP	50	143	111	20	72,7	38	25	16	55,0	358,75 €

Dimensions in mm

# Sealed flange bearing unit for Food Industry

With 4 fixing holes

SBFCL

- Sealed bearing
- Massive, without retention surface
- Resistant to frequent washing and detergents
- Materials
  - 316 stainless steel housing
  - 440 stainless steel bearing
  - Optical and detectable blue hygienic seals
- Complies with EHEDGE hygiene directives

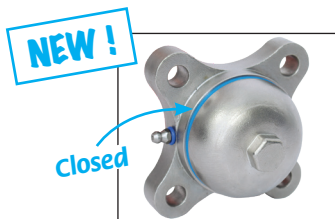

## Application

- For the highly challenging food and beverage industry

## Info

- Stainless steel bearings for the food and beverage industry are completely sealed units with an open or closed cover and a rear seal.

Blue foodgrade cover seal

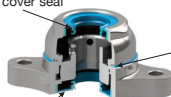

Blue foodgrade back seal



O-ring

DHRGS foodgrade hygienic seal

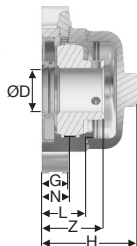
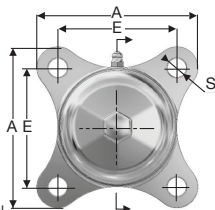

Type	SBF 204	SBF 205	SBF 206	SBF 207	SBF 208	SBF 209	SBF 210
------	---------	---------	---------	---------	---------	---------	---------

of load (N)	15950	13000	18000	18500	19100	19350	19650
-------------	-------	-------	-------	-------	-------	-------	-------

P	10250	12150	17700	18500	19250	19350	19620
---	-------	-------	-------	-------	-------	-------	-------

P	3650	3350	3350	3520	3790	3850	3990
---	------	------	------	------	------	------	------

P							
---	--	--	--	--	--	--	--

P							
---	--	--	--	--	--	--	--

P							
---	--	--	--	--	--	--	--

## DISCOUNTS

Qty	1+	4+	8+
Disc. List	-5%	On request	

Part Number	Diameter								Price each 1 to 3	
	ØD	A	E	G	H	L	N	S		Z
SBF204/CL	20	88	64	15	54,2	24	15	12	33,0	126,05 €
SBF205/CL	25	95	70	15	54,7	25	16	12	35,5	140,59 €
SBF206/CL	30	108	83	15	61,0	29	18	12	40,0	174,53 €
SBF207/CL	35	117	92	17	64,7	31	19	14	42,5	198,77 €
SBF208/CL	40	130	102	17	70,0	32	21	16	46,0	237,55 €
SBF209/CL	45	135	105	18	71,5	33	22	16	53,7	286,03 €
SBF210/CL	50	143	111	20	71,0	38	25	16	55,0	353,90 €

Dimensions in mm

# Sealed flange bearing unit for Food Industry

## SBFLOP

## With 2 fixing holes

- **Sealed bearing**
- Massive, without retention surface
- Resistant to frequent washing and detergents
- Materials
  - 316 stainless steel housing
  - 440 stainless steel bearing
  - Optical and detectable blue hygienic seals
- Complies with EHEDGE hygiene directives

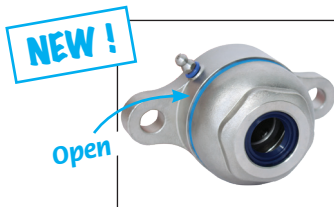

### Application

- For the highly challenging food and beverage industry

### Info

- Stainless steel bearings for the food and beverage industry are completely sealed units with an open or closed cover and a rear seal

Blue foodgrade cover seal

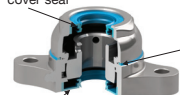

Blue foodgrade back seal



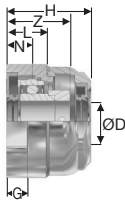
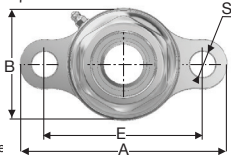

O-ring

DHRGS foodgrade hygienic s



Type	SBFL 204	SBFL 205	SBFL 206	SBFL 207	SBFL 208	SBFL 209	SBFL 210
of load (N)	204	205	206	207	208	209	210

	11750	11375	16450	16900	17350	17600	17950
--	-------	-------	-------	-------	-------	-------	-------

	11000	13850	13350	13950	14050	14300	14550
---	-------	-------	-------	-------	-------	-------	-------

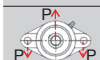
	8500	1100	14200	14900	15150	15350	15650
--	------	------	-------	-------	-------	-------	-------

### DISCOUNTS

Qty	1+	4+	8+
Disc.	List	-5%	On request

Part Number	Diameter											Price each 1 to 3
	ØD	A	B	E	G	H	L	N	S	Z		
SBFL204/OP	20	115	65	90	11	51,9	24	15	12	33,0	130,90 €	
SBFL205/OP	25	130	70	99	13	52,4	25	16	16	35,5	145,44 €	
SBFL206/OP	30	148	80	117	13	58,7	29	18	16	40,0	164,83 €	
SBFL207/OP	35	161	90	130	15	62,4	31	19	16	42,5	193,92 €	
SBFL208/OP	40	175	100	144	15	70,7	32	21	16	46,0	237,55 €	
SBFL209/OP	45	188	110	148	16	69,2	33	22	19	53,7	276,34 €	
SBFL210/OP	50	197	120	157	16	72,7	38	22	19	55,0	324,82 €	

Dimensions in mm

# Sealed flange bearing unit for Food Industry

With 2 fixing holes

SBFLCL

- Sealed bearing
- Massive, without retention surface
- Resistant to frequent washing and detergents
- Materials
  - 316 stainless steel housing
  - 440 stainless steel bearing
  - Optical and detectable blue hygienic seals
- Complies with EHEDGE hygiene directives



## Application

- For the highly challenging food and beverage industry

## Info

- Stainless steel bearings for the food and beverage industry are completely sealed units with an open or closed cover and a rear seal

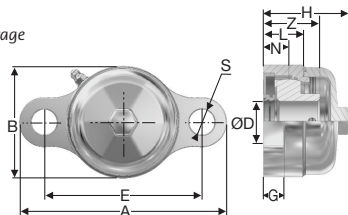
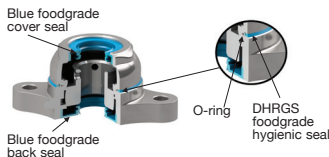

Type	SBFL 204	SBFL 205	SBFL 206	SBFL 207	SBFL 208	SBFL 209	SBFL 210
of load (N)	204	205	206	207	208	209	210

	11750	11375	16450	16900	17350	17600	17950
--	-------	-------	-------	-------	-------	-------	-------

	11000	13850	13350	13950	14050	14300	14550
--	-------	-------	-------	-------	-------	-------	-------

	8500	1100	14200	14900	15150	15350	15650
--	------	------	-------	-------	-------	-------	-------

## DISCOUNTS

Qty	1+	4+	8+
Disc. List	-5%	On request	

Part Number	Diameter										Price each 1 to 3
	ØD	A	B	E	G	H	L	N	S	Z	
SBFL204/CL	20	115	65	90	11	54,2	24	15	12	33,0	121,20 €
SBFL205/CL	25	130	70	99	13	54,7	25	16	16	35,5	130,90 €
SBFL206/CL	30	148	80	117	13	61,0	29	18	16	40,0	155,14 €
SBFL207/CL	35	161	90	130	15	64,7	31	19	16	42,5	184,22 €
SBFL208/CL	40	175	100	144	15	70,0	32	21	16	46,0	223,01 €
SBFL209/CL	45	188	110	148	16	71,5	33	22	19	53,7	261,79 €
SBFL210/CL	50	197	120	157	16	71,0	38	22	19	55,0	315,12 €

Dimensions in mm

# Sealed flange bearing unit for Food Industry

## SBFB<sub>OP</sub>

### With 3 offset fixing points

- **Sealed bearing**
- Massive, without retention surface
- Resistant to frequent washing and detergents
- Materials
  - 316 stainless steel housing
  - 440 stainless steel bearing
  - Optical and detectable blue hygienic seals
- Complies with EHEDGE hygiene directives

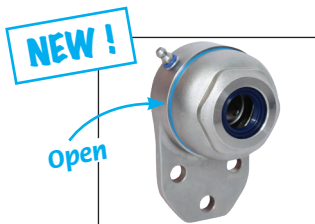

## Application

- For the highly challenging food and beverage industry

## Info

- Stainless steel bearings for the food and beverage industry are completely sealed units with an open or closed cover and a rear seal.

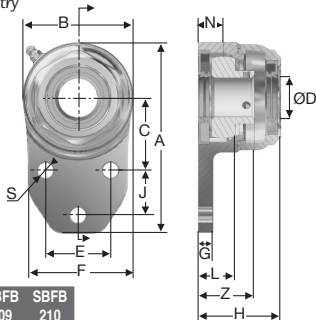
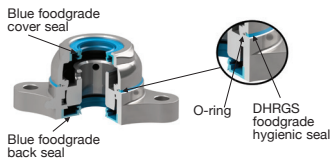

Type of load (N)	SBFB 204	SBFB 205	SBFB 206	SBFB 207	SBFB 208	SBFB 209	SBFB 210
------------------	----------	----------	----------	----------	----------	----------	----------

	-	-	-	7200	9100	12200	12900
	-	-	-	9200	11100	11800	11900
	-	-	-	2600	2800	2900	3100

## DISCOUNTS

Qty	1+	4+	8+
Disc.	List	-5%	On request

Part Number	Diameter													Price each 1 to 3
	ØD	A	B	C	E	F	G	H	J	L	N	S	Z	
SBFB204/OP	20	108	65	43,3	38,1	60,3	8,0	51,9	22,0	24	15	10	33,0	140,59 €
SBFB205/OP	25	121	70	46,0	41,3	63,5	9,5	52,9	28,5	25	16	10	35,5	164,83 €
SBFB206/OP	30	137	80	52,4	47,6	70,0	9,5	58,7	31,7	29	18	10	40,0	184,22 €
SBFB207/OP	35	156	90	60,3	50,8	83,0	12,7	62,4	31,7	31	19	13	42,5	227,86 €
SBFB208/OP	40	164	100	60,3	50,0	78,0	15,9	70,7	41,3	32	21	12	46,0	271,49 €
SBFB209/OP	45	176	110	65,0	54,0	80,0	18,3	69,2	42,9	33	22	12	53,7	324,82 €
SBFB210/OP	50	190	120	74,6	70,0	102,0	12,7	72,5	41,3	38	22	13	55,0	373,30 €

Dimensions in mm

# Sealed flange bearing unit for Food Industry

With 3 offset fixing points

SBFBCL

- Sealed bearing
- Massive, without retention surface
- Resistant to frequent washing and detergents
- Materials
  - B316 stainless steel housing
  - 440 stainless steel bearing
  - Optical and detectable blue hygienic seals
- Complies with EHEDGE hygiene directives

## Application

- For the highly challenging food and beverage industry

## Info

- Stainless steel bearings for the food and beverage industry are completely sealed units with an open or closed cover and a rear seal.

Blue foodgrade cover seal

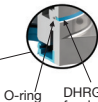
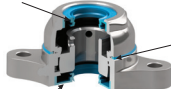

Blue foodgrade back seal

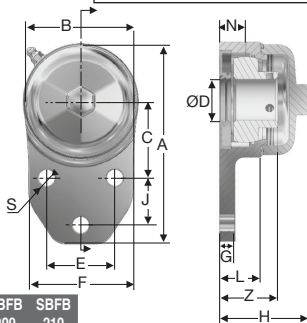

Type of load (N)	SBFB 204	SBFB 205	SBFB 206	SBFB 207	SBFB 208	SBFB 209	SBFB 210
------------------	----------	----------	----------	----------	----------	----------	----------

	-	-	-	7200	9100	12200	12900
--	---	---	---	------	------	-------	-------

	-	-	-	9200	11100	11800	11900
--	---	---	---	------	-------	-------	-------

	-	-	-	2600	2800	2900	3100
--	---	---	---	------	------	------	------

## DISCOUNTS

Qty	1+	4+	8+
Disc.	List	-5%	On request

Part Number	Diameter													Price each 1 to 3
	ØD	A	B	C	E	F	G	H	J	L	N	S	Z	
SBFB204/CL	20	108	65	43,3	38,1	60,3	8,0	54,2	22,0	24	15	10	33,0	130,90 €
SBFB205/CL	25	121	70	46,0	41,3	63,5	9,5	54,7	28,5	25	16	10	35,5	150,29 €
SBFB206/CL	30	137	80	52,4	47,6	70,0	9,5	61,0	31,7	29	18	10	40,0	179,38 €
SBFB207/CL	35	156	90	60,3	50,8	83,0	12,7	64,7	31,7	31	19	13	42,5	218,16 €
SBFB208/CL	40	164	100	60,3	50,0	78,0	15,9	70,0	41,3	32	21	12	46,0	256,94 €
SBFB209/CL	45	176	110	65,0	54,0	80,0	18,3	71,5	42,9	33	22	12	53,7	310,27 €
SBFB210/CL	50	190	120	74,6	70,0	102,0	12,7	71,0	41,3	38	22	13	55,0	363,60 €

Dimensions in mm

## Our other products



G4

Steel spur gear, Steel  
20NCD2



G-ECO

Eco range Spur gear,  
Steel C45

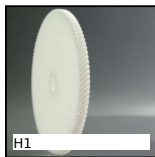

H1

Crossed helical gear  
crossed axis at 90°,  
Machined plastic  
(delrin)



INS

Self tapping steel  
insert, Steel



SLBE

Indexing plunger -  
Spacer, Spacer for  
SLB and SLBS index  
bolts



YG2

HEAVY DUTY spur  
gear, Steel 35NCD6



LR

Precision locknut,  
Precision locknut



DOMI80

Connecting kits, XZ  
linking kit



PSG35

Spur gear - precision  
gear, Stainless steel



BPHF

Ball transfer unit push  
fit, Heavy



ERF

Quick fitting threaded  
cable terminal, Cable



SSB

Stainless steel bevel  
gear, 1:1

## Complementary products



UCFL\_SS

Stainless steel flanged  
bearing, Stainless  
steel



UCFL\_PBT

Stainless  
steel/Polymer flanged  
bearing, Polymer and  
stainless steel



UCFL\_PBT

Stainless  
steel/Polymer flanged  
bearing, Polymer and  
stainless steel



UCFL

Cast iron flanged  
bearing, Cast iron