

Wear strip for plate chain



PRL "L" profile wear strip for plate chain

- Wear strip for mounting plate chains, "clip on" mounting
- Can be used with plate thicknesses 1.5 to 3mm
- Material:
Green DESLIDUR Polyethylene (UHMW 1000)

Info.

- Supplied in 50 metre rolls

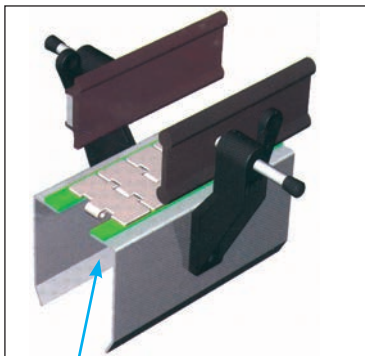
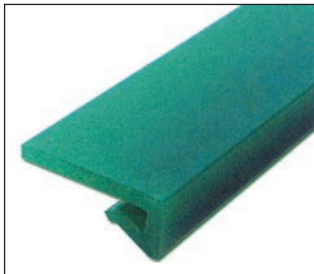

Typical application

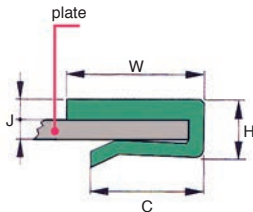

DISCOUNTS

Qty	1+	5+	10+
Disc.	List	-5%	On request

Part number	W	H	C	J	Weight (kg/m)	Price each 1 to 4
PRL-20C	20	10,5	14,5	3	0,11	227,10 €
PRL-25C	25	10,5	20,0	3	0,12	227,10 €
PRL-40C	40	10,3	20,0	3	0,16	271,65 €

Dimensions in mm

Our other products

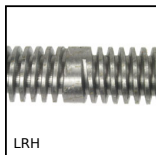

LRH

Bi-directional leadscrew, Bi-directional - 1 thread



GSA_A

Adjustable gas spring, Steel



GARQT

Quarter turn lock pin for clamping, Quarter turn



AC144

Strike for toggle latch, 22mm

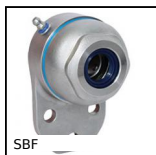

SBF

Sealed flange bearing unit for Food Industry, cover



CLG2

Moulded plastic spur gear, Moulded plastic (nylon)



PTRSS

Idle chain sprocket, For hostile environments



RTE

Rotex®, jaw coupling, cast iron



PDD

Actuating plunger, Non-rotating detector



UCP_PBT

Stainless/Polymer pillow block bearing,

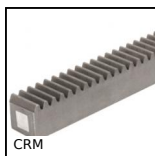

CRM

Moulded nylon rack, Nylon



WJUM20

Drylin®, W bearing block, Slide

Complementary products

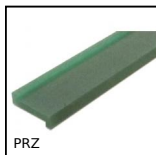

PRZ

Wear strip for slat top chain, Z profile to be clipped

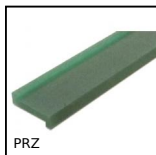

PRZ

Wear strip for slat top chain, Z profile to be filled



CAP820

Slim slat top chain acetal, Narrow straight range 820



CAP821

Slat top chain acetal, Large range 821