

4A motorised linear actuator



LAT4

4 Amp

- 4 Amp motor, Supply 12V dc
- Accuracy: +/-0.2mm
- Material:
Trapezoidal threaded screw:
stainless steel AISI430F
- Flexible leadscrew is sold by the metre with un-finished ends

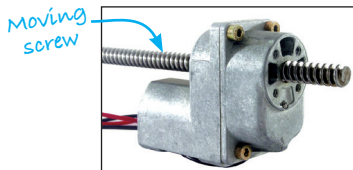

Advantages

- Screws have M4/M5 threaded ends for easy connection
- Protected by sheaths, flexible shafts allow valves, doors or traps to be operated at a distance
E.g. electric car windows

Options

- Available in lengths up to 1000mm
- Flexible leadscrew sold by the metre

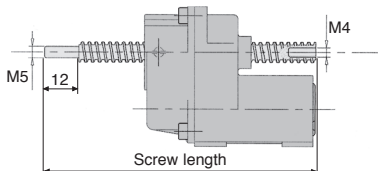

DISCOUNTS

Qty	1+	2+	5+
Disc.	List	-15%	On request

Part number	Ratio	Pitch (mm)	Ext. screw Ø (mm)	Screw length (mm)	Stroke (mm)	Bending radius (mm)	Price each
Stainless steel leadscrew 3mm pitch							
LAT4-12-3-200	1/12	3,0	8,8	200	141	-	135,34 €
LAT4-12-3-300	1/12	3,0	8,8	300	241	-	135,34 €
LAT4-12-3-400	1/12	3,0	8,8	400	341	-	135,34 €
LAT4-48-3-200	1/48	3,0	8,8	200	141	-	135,34 €
LAT4-48-3-300	1/48	3,0	8,8	300	241	-	135,34 €
LAT4-48-3-400	1/48	3,0	8,8	400	341	-	135,34 €
LAT4-108-3-200	1/108	3,0	8,8	200	141	-	135,34 €
LAT4-108-3-300	1/108	3,0	8,8	300	241	-	135,34 €
LAT4-108-3-400	1/108	3,0	8,8	400	341	-	135,34 €
Stainless steel leadscrew 10mm pitch							
LAT4-12-10-200	1/12	10,0	7,9	200	141	-	135,34 €
LAT4-12-10-300	1/12	10,0	7,9	300	241	-	135,34 €
LAT4-12-10-400	1/12	10,0	7,9	400	341	-	135,34 €
LAT4-48-10-200	1/48	10,0	7,9	200	141	-	135,34 €
LAT4-48-10-300	1/48	10,0	7,9	300	241	-	135,34 €
LAT4-48-10-400	1/48	10,0	7,9	400	341	-	135,34 €
LAT4-108-10-200	1/108	10,0	7,9	200	141	-	135,34 €
LAT4-108-10-300	1/108	10,0	7,9	300	241	-	135,34 €
LAT4-108-10-400	1/108	10,0	7,9	400	341	-	135,34 €
Steel flexible leadscrew 3.5mm pitch							
LAT4-12-FLX	1/12	3,5	6,2	1000	941	60	135,34 €
LAT4-48-FLX	1/48	3,5	6,2	1000	941	60	135,34 €
LAT4-108-FLX	1/108	3,5	6,2	1000	941	60	135,34 €

*Depending on availability - Dimensions in mm

Performance characteristics

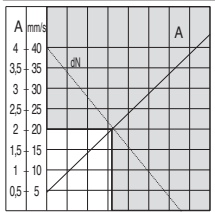

LAT4-12

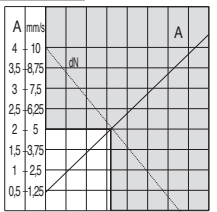

LAT4-48

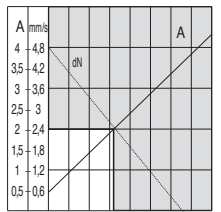

LAT4-108

4A Duty cycle (12V) : 20% On 80% Off

Important : motor only available in 12 V DC version.

Note :

- Optimum power obtained at 50% of max current (see light area of graph)
- Max working temperature: 70°C
- Thermal protection available, contact us for details

Note, these tables are for trapezoidal screws with a pitch of 3mm. For a pitch of 10mm, simply divide the loads by 10/3 and multiply the speeds by 10/3 (ditto for screws with a pitch of 3.5mm with the factor 3.5/3).

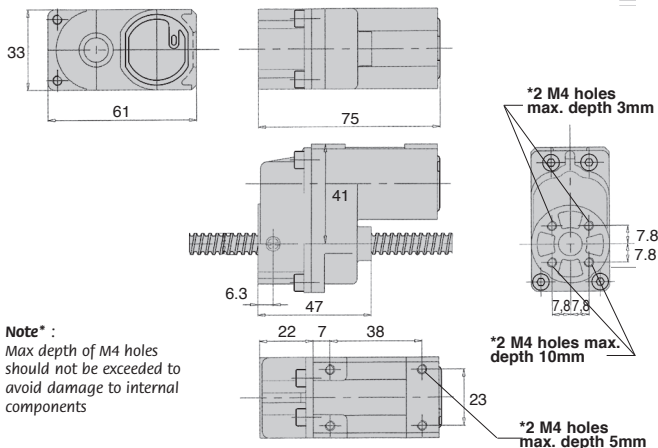

Our other products



SLB

Indexing plunger,
steel class 5.8



RPCpl

Fixed castor with
plate, Steel -
Polyamide



UTKpwrr

V shaped channel
UtiliTrak®, V rail



RT70

Self-centering locking
Assembly,
Medium/high torque



INS

Self tapping steel
insert, Steel



R204

Die spring ISO10243,
Average



RPCtcss

Swivel castor with
central hole, Stainless
steel - Polyamide

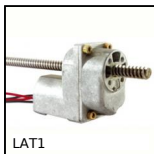

LAT1

1A motorised linear
actuator, 1 ampere



APB_T

Adjusting rod for
clamp - Female, Bored



CHAsb28

Roll of hinge without
pin, Plastic hinge



PCLA_T

Technopolymer
clamping lever - male,



SSB

Stainless steel bevel
gear, 1:1

Complementary products