

2A motorised linear actuator Stock

LAT2

2 Amp

- 2 Amp motor, supply 12-24V dc
- Accuracy: +/-0.2mm
- Material:

Trapezoidal threaded screw:
stainless steel AISI430F

- Flexible leadscrew is sold by the metre with un-finished ends

Moving screw

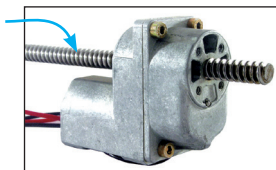

Advantages

- Screws have M4/M5 threaded ends for easy connection
- Protected by sheaths, flexible shafts allow valves, doors or traps to be operated at a distance
E.g. electric car windows

Options

- Available in lengths up to 1000mm
- Flexible leadscrew sold by the metre

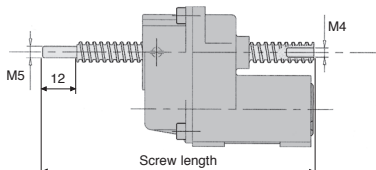

DISCOUNTS

Qty	1+	2+	5+
Disc.	List	-15%	On request

Part number	Ratio	Pitch (mm)	Ext. screw Ø (mm)	Screw length (mm)	Stroke (mm)	Bending radius (mm)	Stock*	Price each
Stainless steel leadscrew 3mm pitch								
LAT2-12-3-200	1/12	3,0	8,8	200	141	-	✓	135,34 €
LAT2-12-3-300	1/12	3,0	8,8	300	241	-	-	135,34 €
LAT2-12-3-400	1/12	3,0	8,8	400	341	-	✓	135,34 €
LAT2-48-3-200	1/48	3,0	8,8	200	141	-	✓	135,34 €
LAT2-48-3-300	1/48	3,0	8,8	300	241	-	-	135,34 €
LAT2-48-3-400	1/48	3,0	8,8	400	341	-	✓	135,34 €
LAT2-108-3-200	1/108	3,0	8,8	200	141	-	✓	135,34 €
LAT2-108-3-300	1/108	3,0	8,8	300	241	-	-	135,34 €
LAT2-108-3-400	1/108	3,0	8,8	400	341	-	✓	135,34 €
Stainless steel leadscrew 10mm pitch								
LAT2-12-10-200	1/12	10,0	7,9	200	141	-	-	135,34 €
LAT2-12-10-300	1/12	10,0	7,9	300	241	-	-	135,34 €
LAT2-12-10-400	1/12	10,0	7,9	400	341	-	✓	135,34 €
LAT2-48-10-200	1/48	10,0	7,9	200	141	-	-	135,34 €
LAT2-48-10-300	1/48	10,0	7,9	300	241	-	-	135,34 €
LAT2-48-10-400	1/48	10,0	7,9	400	341	-	-	135,34 €
LAT2-108-10-200	1/108	10,0	7,9	200	141	-	-	135,34 €
LAT2-108-10-300	1/108	10,0	7,9	300	241	-	-	135,34 €
LAT2-108-10-400	1/108	10,0	7,9	400	341	-	✓	135,34 €
Steel flexible leadscrew 3.5mm pitch								
LAT2-12-FLX	1/12	3,5	6,2	1000	941	60	-	135,34 €
LAT2-48-FLX	1/48	3,5	6,2	1000	941	60	-	135,34 €
LAT2-108-FLX	1/108	3,5	6,2	1000	941	60	-	135,34 €

*Depending on availability - Dimensions in mm

Performance characteristics

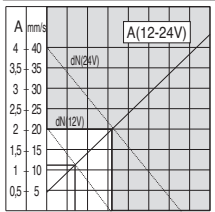

LAT2-12

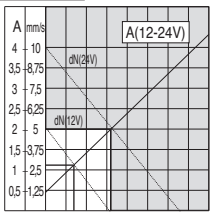

LAT2-48

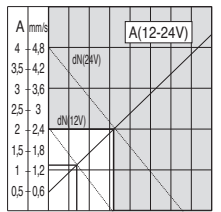

LAT2-108

2A Duty cycle (12V) : 50% On 50% Off
2A Duty cycle (24V) : 20% On 80% Off

Note:

- Optimum power obtained at 50% of max current (see light area of graph)
- Max working temperature: 70°C
- Thermal protection available, contact us for details

Note, these tables are for trapezoidal screws with a pitch of 3mm. For a pitch of 10mm, simply divide the loads by 10/3 and multiply the speeds by 10/3 (Similarly for screws with a pitch of 3.5mm, use a factor of 3.5/3.).

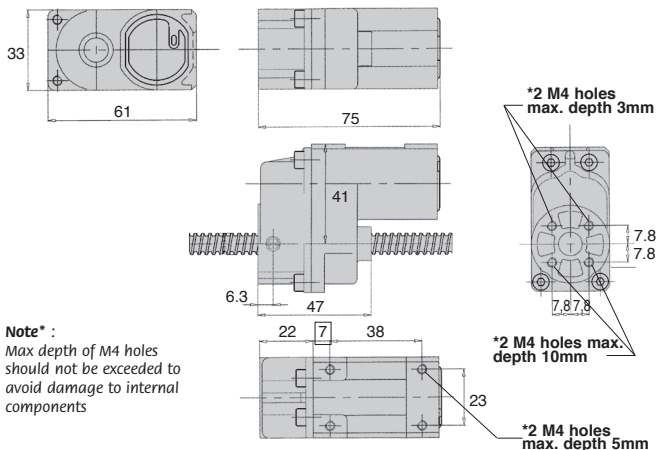

Note* :

Max depth of M4 holes should not be exceeded to avoid damage to internal components

Our other products



RJUM05
Drylin R® linear bearing housing, Closed - Long



UGPC
Actuator guide kit, Short bearing



NRV
Orthogonal support clamp, Orthogonal support clamp



DOMI50
Domino 50 adjustable slide, Slide DOMILINE 50



GLT3E-50
Telescopic drawer,



DER80
Stainless steel AC asynchronous motor 0.55 - 0.75kW, 0.55 to 0.75kW



PRES
Manual workbench press accessory for PRES-3HR end PRES-4HR, Micromet...



P60
Worm and wheel gear reducer, up to 118 Nm



PITAss
Locking bolt, with T handle



CHN_CHNSS
Straight long link chain, Galvanised



CCLSS
Stainless steel wire thimble, Stainless



ZBconique
Machined plastic bevel gear, 1:1

Complementary products



LVT
Miniature motorised actuator 1A, 1 amp

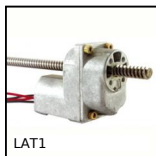

LAT1
1A motorised linear actuator, 1 ampere



LVT
Miniature motorised actuator 2A, 2 amper



LVT
Miniature motorised actuator 2A, 2 amper