



Single and dual output gearboxes

Torque up to 4.7Nm

CHTRB8

- Gearbox with one or two outputs
- Ratios from 1:1 to 2:1
- Maximum speed 3,000 rpm
- Lubrication: Synthetic oil
- Material :
 - Housing: Cast aluminium
 - Gears: Steel 16CrN4
- Operating temperature -20° to +80°C

Info.

- Max. axial load : 210N
- Max. radial load at 7,5mm : 110N
- If used as a multiplier, the maximum input speed is 750 rpm for gearboxes with a 2:1 ratio.

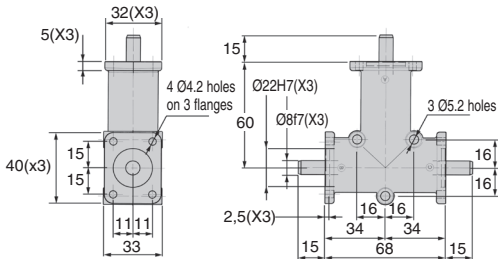
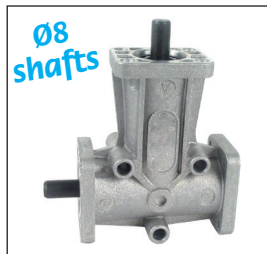

OUTPUT TORQUE (Nm: VALUES GIVEN AS A GUIDE ONLY)

Ratios	1:1	2:1
3000	1,7	1,4
2000	1,8	1,6
1400	2,0	1,7
800	2,3	2,0
400	2,8	2,4
200	3,3	2,8
100	3,9	3,4
50	4,7	4,0

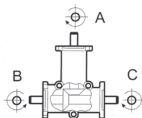

DISCOUNTS

Qty	1+	2+	4+
Disc.	List -15%		On request

Part number	Type	Ratio	Input	Output	Max. input	Max. output	Weight (kg)	Stock*	Price each
					speed (rpm)	speed (rpm)			
CHTRB8-1-1	1	1:1	A	B	3000	3000	0,3	✓	155,45 €
CHTRB8-2-1	2	1:1	A	C	3000	3000	0,3	✓	155,45 €
CHTRB8-3-2	3	2:1	A	B	3000	1500	0,3	✓	155,45 €
CHTRB8-4-2	4	2:1	A	C	3000	1500	0,3	-	155,45 €
CHTRB8-5-1	5	1:1	A	B-C	3000	3000	0,3	✓	163,36 €
CHTRB8-6-2	6	2:1	A	B-C	3000	1500	0,3	-	163,36 €

Depending of availability - Dimensions in mm

Single and dual output gearboxes

CHTRB15

Torque up to 16.5Nm

- Gearbox with one or two outputs
- Ratios from 1:1 to 2:1
- Maximum speed 3,000 rpm
- Lubrication: Synthetic oil
- Material :
 - Housing: Cast aluminium
 - Gears: Steel 16CrN4
- Operating temperature -20° to +80°C

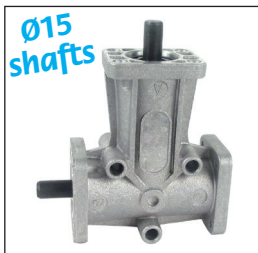

Info.

- Max. axial load : 410N
- Max. radial load at 17,5mm : 200N
- If used as a multiplier, the maximum input speed is 750 rpm for gearboxes with a 2:1 ratio.

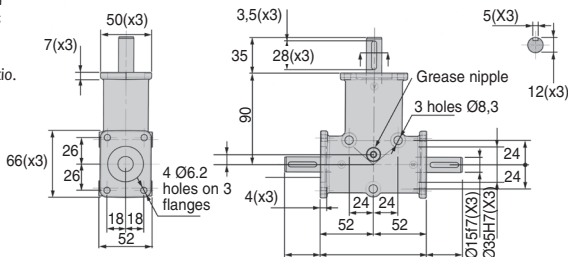

OUTPUT TORQUE (Nm: VALUES GIVEN AS A GUIDE ONLY)

Ratios		1:1	2:1
INPUT SPEED (rpm)	3000	5,9	5,2
	2000	6,6	5,8
	1400	7,2	6,3
	800	8,2	7,3
	400	9,8	8,7
	200	11,7	10,3
	100	13,9	12,3
	50	16,5	14,6

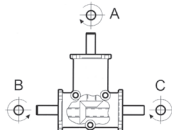

DISCOUNTS

Qty	1+	2+	4+
Disc.	List -15%	On request	On request

Part number	Type	Ratio	Input	Output	Max. input speed (rpm)	Max. output speed (rpm)	Weight (kg)	Price each
CHTRB15-1-1	1	1:1	A	B	3000	3000	1,1	202,35 €
CHTRB15-2-1	2	1:1	A	C	3000	3000	1,1	202,35 €
CHTRB15-3-2	3	2:1	A	B	3000	1500	1,1	202,35 €
CHTRB15-4-2	4	2:1	A	C	3000	1500	1,1	202,35 €
CHTRB15-5-1	5	1:1	A	B-C	3000	3000	1,2	211,02 €
CHTRB15-6-2	6	2:1	A	B-C	3000	1500	1,2	211,02 €

Depending of availability - Dimensions in mm



Single and dual output gearboxes

Torque up to 53.1Nm

CHTRB20

- Gearbox with one or two outputs
- Ratios from 1:1 to 2:1
- Maximum speed 3,000 rpm
- Lubrication: Synthetic oil
- Material:
 - Housing: Cast aluminium
 - Gears: Steel 16CrN4
- Operating temperature -20° to +80°C

Info.

- Max. axial load : 760N
- Max. radial load at 25mm : 430N
- If used as a multiplier, the maximum input speed is 750 rpm for gearboxes with a 2:1 ratio.

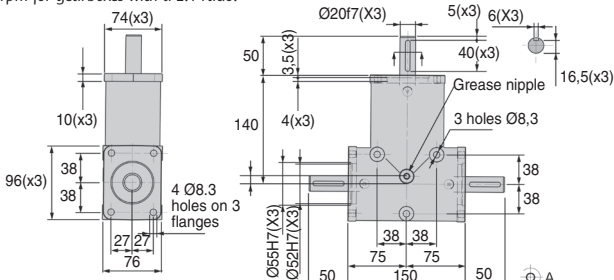

OUTPUT TORQUE (Nm: VALUES GIVEN AS A GUIDE ONLY)

Ratios	1:1	2:1
3000	19,1	15,3
2000	21,1	16,9
1400	23,1	18,5
INPUT SPEED (rpm)		
800	26,5	21,3
400	31,6	25,3
200	37,5	30,1
100	44,6	35,7
50	53,1	42,5

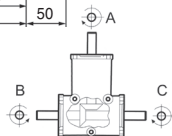

DISCOUNTS

Qty	1+	2+	4+
Disc.	List -15%	On request	On request

Part number	Type	Ratio	Input	Output	Max. input	Max. output	Weight (kg)	Stock*	Price each
					speed (rpm)	speed (rpm)			
CHTRB20-1-1	1	1:1	A	B	3000	3000	3,4	✓	287.53 €
CHTRB20-2-1	2	1:1	A	C	3000	3000	3,4	-	287.53 €
CHTRB20-3-2	3	2:1	A	B	3000	1500	3,4	-	287.53 €
CHTRB20-4-2	4	2:1	A	C	3000	1500	3,4	✓	287.53 €
CHTRB20-5-1	5	1:1	A	B-C	3000	3000	3,5	✓	292.13 €
CHTRB20-6-2	6	2:1	A	B-C	3000	1500	3,5	✓	292.13 €

Depending of availability - Dimensions in mm

Single and dual output gearboxes

CHTRB25

Torque up to 87.3Nm

- Gearbox with one or two outputs
- Ratios from 1:1 to 2:1
- Maximum speed 3,000 rpm
- Lubrication: Synthetic oil
- Material:
 - Housing: Cast aluminium
 - Gears: Steel 16CrN4
- Operating temperature -20° to +80°C

Info.

- Max. axial load : 880N
- Max. radial load at 35mm : 490N
- If used as a multiplier, the maximum input speed is 750 rpm for gearboxes with a 2:1 ratio.

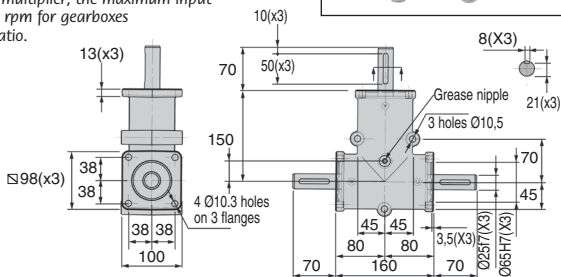

OUTPUT TORQUE (Nm: VALUES GIVEN AS A GUIDE ONLY)

Ratios		1:1	2:1
	3000	31,4	29,6
	2000	34,7	32,7
	1400	38,0	35,8
INPUT SPEED (rpm)	800	43,7	41,1
	400	51,9	48,9
	200	61,8	58,2
	100	73,4	69,2
	50	87,3	82,3

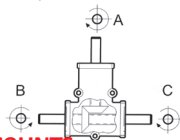

DISCOUNTS

Qty	1+	2+	4+
Disc.	List	-15%	On request

Part number	Type	Ratio	Input	Output	Max. input speed (rpm)	Max. output speed (rpm)	Weight (kg)	Price each
CHTRB25-1-1	1	1:1	A	B	3000	3000	5,5	356.67 €
CHTRB25-2-1	2	1:1	A	C	3000	3000	5,5	356.67 €
CHTRB25-3-2	3	2:1	A	B	3000	1500	5,5	356.67 €
CHTRB25-4-2	4	2:1	A	C	3000	1500	5,5	356.67 €
CHTRB25-5-1	5	1:1	A	B-C	3000	3000	5,8	369.52 €
CHTRB25-6-2	6	2:1	A	B-C	3000	1500	5,8	369.52 €

Dimensions in mm



Single and dual output gearboxes

Torque up to 9.1Nm

CHTRP8

- Gearbox with one or two outputs
- Ratios from 1:1 to 2:1
- Maximum speed 3,000 rpm
- Lubrication: Synthetic oil
- Material:
 - Housing: Cast aluminium
 - Gears: Steel 16CrN4
- Operating temperature -20° to +80°C

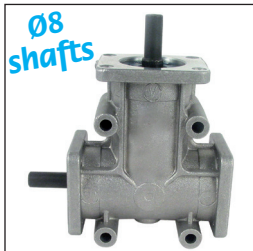

Info.

- Max. axial load : 280N
- Max. radial load at 10mm : 150N
- If used as a multiplier, the maximum input speed is 750 rpm for gearboxes with a 2:1 ratio.

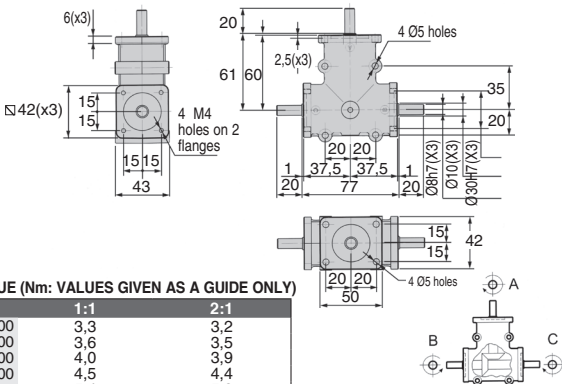

OUTPUT TORQUE (Nm: VALUES GIVEN AS A GUIDE ONLY)

Ratios	1:1	2:1
3000	3,3	3,2
2000	3,6	3,5
1400	4,0	3,9
800	4,5	4,4
400	5,4	5,3
200	6,4	6,3
100	7,6	7,5
50	9,1	8,9

DISCOUNTS

Qty	1+	6+	20+	40+
Disc.	List	-15%	-20%	On request

Part number	Type	Ratio	Input	Output	Max. input speed (rpm)	Max. output speed (rpm)	Weight (kg)	Price each	Stock*
									1 to 5
CHTRP8-1-1	1	1:1	A	B	3000	3000	0,6	✓	213,79 €
CHTRP8-2-1	2	1:1	A	C	3000	3000	0,6	✓	213,79 €
CHTRP8-3-2	3	2:1	A	B	3000	1500	0,6	✓	241,47 €
CHTRP8-4-2	4	2:1	A	C	3000	1500	0,6	-	241,49 €
CHTRP8-5-1	5	1:1	A	B-C	3000	3000	0,6	✓	226,61 €
CHTRP8-6-2	6	2:1	A	B-C	3000	1500	0,6	-	256,35 €

Depending of availability - Dimensions in mm

Single and dual output gearboxes

CHTRP14

Torque up to 34.5Nm

- Gearbox with one or two outputs
- Ratios from 1:1 to 3:1
- Maximum speed 3,000 rpm
- Lubrication: Synthetic oil
- Material:
 - Housing: Cast aluminium
 - Gears: Steel 16CrN4
- Operating temperature -20° to +80°C

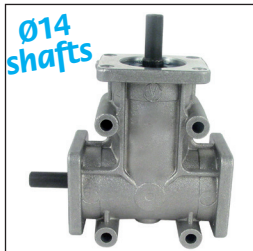

Info.

- Max. axial load : 530N
- Max. radial load at 15mm : 300N
- If used as a multiplier, the maximum input speed is 750 rpm for gearboxes with a 2:1 ratio and 500 rpm for a 3:1 ratio.

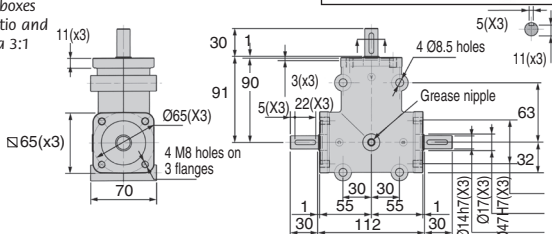

OUTPUT TORQUE (Nm: VALUES GIVEN AS A GUIDE ONLY)

Ratios	1:1	2:1	3:1
3000	12,4	12,2	9,9
2000	13,7	13,5	10,9
1400	15,0	14,7	12,0
INPUT SPEED (rpm)	800	17,2	16,9
400	20,5	20,1	16,3
200	24,4	23,9	19,4
100	29,0	28,5	23,1
50	34,5	33,8	27,5

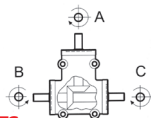

DISCOUNTS

Qty	1+	6+	20+	40+
Disc.	List	-15%	-20%	On request

Part number	Type	Ratio	Input	Output	Max. input speed (rpm)	Max. output speed (rpm)	Weight (kg)	Price each
CHTRP14-1-1	1	1:1	A	B	3000	3000	2	259.02 €
CHTRP14-2-1	2	1:1	A	C	3000	3000	2	259.02 €
CHTRP14-3-2	3	2:1	A	B	3000	1500	2	277.83 €
CHTRP14-4-2	4	2:1	A	C	3000	1500	2	277.83 €
CHTRP14-5-3	5	3:1	A	B	3000	1000	2	284.23 €
CHTRP14-6-3	6	3:1	A	C	3000	1000	2	284.23 €
CHTRP14-7-1	7	1:1	A	B-C	3000	3000	2	284.23 €
CHTRP14-8-2	8	2:1	A	B-C	3000	1500	2	297.53 €
CHTRP14-9-3	9	3:1	A	B-C	3000	1000	2	319.71 €

Depending of availability - Dimensions in mm



Single and dual output gearboxes

Torque up to 28.8Nm

CHTRP14

- Gearbox with one or two outputs
- Ratios from 1:1 to 3:1
- Maximum speed 3,000 rpm
- Lubrication: Synthetic oil
- Material:
 - Housing: Cast aluminium
 - Gears: Steel 16CrN4
- Operating temperature -20° to +80°C

Ø14 hollow output shaft

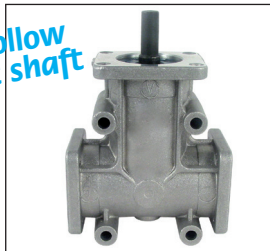

Info.

- Max. axial load : 530N
- Max. radial load at 15mm : 300N
- If used as a multiplier, the maximum input speed is 750 rpm for gearboxes with a 2:1 ratio and 500 rpm for a 3:1 ratio.

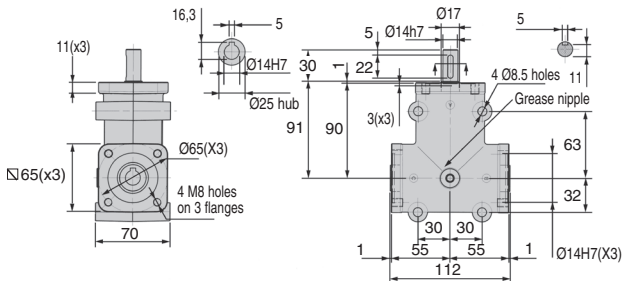

OUTPUT TORQUE (Nm: VALUES GIVEN AS A GUIDE ONLY)

Ratios	1:1	2:1	3:1
3000	10,3	10,1	9,9
2000	11,4	11,2	10,9
1400	12,5	12,2	12,0
800	14,4	14,1	13,7
400	17,1	16,7	16,3
200	20,3	19,9	19,4
100	24,2	23,7	23,1
50	28,8	28,1	27,5

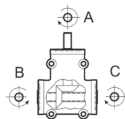

DISCOUNTS

Qty	1+	6+	20+	40+
Disc.	List	-15%	-20%	On request

Part number	Type	Ratio	Input	Output	Max. input speed (rpm)	Max. output speed (rpm)	Weight (kg)	Price each 1 to 5
CHTRP14-10-1	10	1:1	A	B-C	3000	3000	2	325.84 €
CHTRP14-11-2	11	2:1	A	B-C	3000	1500	2	351.98 €
CHTRP14-12-3	12	3:1	A	B-C	3000	1000	2	379.13 €

Depending of availability - Dimensions in mm

Single and dual output gearboxes

CHTRP19

Torque up to 87.3Nm

- Gearbox with one or two outputs
- Ratios from 1:1 to 3:1
- Maximum speed 3,000 rpm
- Lubrication: Synthetic oil
- Material:
 - Housing: Cast aluminium
 - Gears: Steel 16CrN4
- Operating temperature -20° to +80°C

Info.

- Max. axial load : 650N
- Max. radial load at 20mm : 450N
- If used as a multiplier, the maximum input speed is 750 rpm for gearboxes with a 2:1 ratio and 500 rpm for a 3:1 ratio.

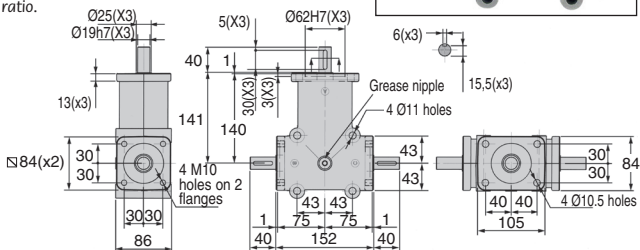
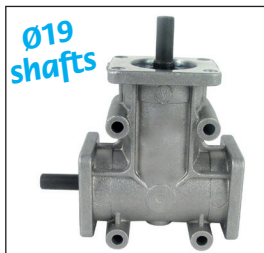

OUTPUT TORQUE (Nm: VALUES GIVEN AS A GUIDE ONLY)

Ratios	1:1	2:1	3:1
3000	31,4	29,6	22,8
2000	34,7	32,7	25,2
1400	38,0	35,8	27,6
INPUT SPEED (rpm)	800	43,7	41,1
400	51,9	48,9	37,7
200	61,8	58,2	44,9
100	73,4	69,2	53,3
50	87,3	82,3	63,4

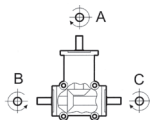

DISCOUNTS

Qty	1+	6+	20+	40+
Disc.	List	-15%	-20%	On request

Part number	Type	Ratio	Input	Output	Max. input speed (rpm)	Max. output speed (rpm)	Weight (kg)	Stock*	Price each
									1 to 5
CHTRP19-1-1	1	1:1	A	B	3000	3000	4,5	✓	379.01 €
CHTRP19-2-1	2	1:1	A	C	3000	3000	4,5	-	379.01 €
CHTRP19-3-2	3	2:1	A	B	3000	1500	4,5	-	396.87 €
CHTRP19-4-2	4	2:1	A	C	3000	1500	4,5	-	396.85 €
CHTRP19-5-3	5	3:1	A	B	3000	1000	4,5	✓	414.85 €
CHTRP19-6-3	6	3:1	A	C	3000	1000	4,5	-	414.89 €
CHTRP19-7-1	7	1:1	A	B-C	3000	3000	4,5	✓	378.89 €
CHTRP19-8-2	8	2:1	A	B-C	3000	1500	4,5	-	402.52 €
CHTRP19-9-3	9	3:1	A	B-C	3000	1000	4,5	✓	431.67 €

Depending of availability - Dimensions in mm



Single and dual output gearboxes

Torque up to 75.7Nm

CHTRP19

- Gearbox with one or two outputs
- Ratios from 1:1 to 3:1
- Maximum speed 3,000 rpm
- Lubrication: Synthetic oil
- Material:
 - Housing: Cast aluminium
 - Gears: Steel 16CrN4
- Operating temperature -20° to +80°C

Ø19 hollow output shafts

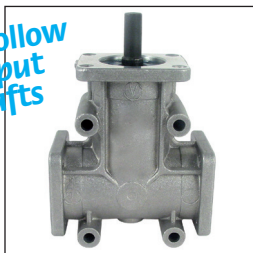

Info.

- Max. axial load : 650N
- Max. radial load at 20mm : 450N
- If used as a multiplier, the maximum input speed is 750 rpm for gearboxes with a 2:1 ratio and 500 rpm for a 3:1 ratio.

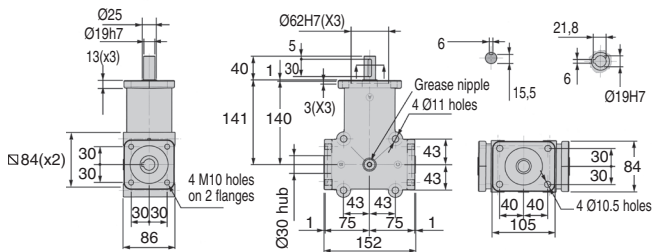

OUTPUT TORQUE (Nm: VALUES GIVEN AS A GUIDE ONLY)

Ratios	1:1	2:1	3:1
3000	27,2	26,6	22,8
2000	30,1	28,3	25,2
1400	32,9	31,0	27,6
800	37,9	35,6	31,7
400	45,0	42,4	37,7
200	53,5	50,4	44,9
100	63,7	59,9	53,3
50	75,7	71,3	63,4

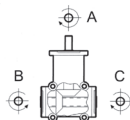

DISCOUNTS

Qty	1+	6+	20+	40+
Disc.	List	-15%	-20%	On request

Part number	Type	Ratio	Input	Output	Max. input speed (rpm)	Max. output speed (rpm)	Weight (kg)	Price each 1 to 5
CHTRP19-10-1	10	1:1	A	B-C	3000	3000	4,5	489,85 €
CHTRP19-11-2	11	2:1	A	B-C	3000	1500	4,5	578,90 €
CHTRP19-12-3	12	3:1	A	B-C	3000	1000	4,5	667,13 €

Depending of availability - Dimensions in mm

Single and dual output gearboxes

CHTRP24

Torque up to 87.3Nm

- Gearbox with one or two outputs
- Ratios from 1:1 to 3:1
- Maximum speed 3,000 rpm
- Lubrication: Synthetic oil
- Material:
 - Housing: Cast aluminium
 - Gears: Steel 16CrN4
- Operating temperature -20° to +80°C

Info.

- Max. axial load : 800N
- Max. radial load at 25mm : 600N
- If used as a multiplier, the maximum input speed is 750 rpm for gearboxes with a 2:1 ratio and 500 rpm for a 3:1 ratio.

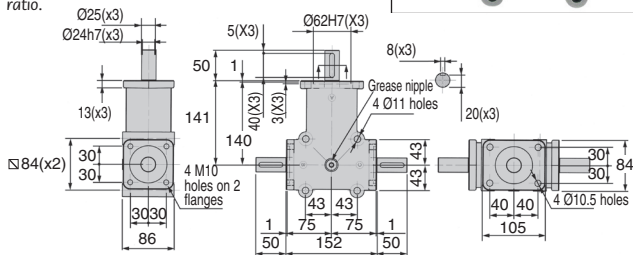
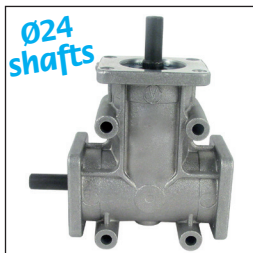

OUTPUT TORQUE (Nm: VALUES GIVEN AS A GUIDE ONLY)

Ratios	1:1	2:1	3:1
3000	31,4	29,6	22,8
2000	34,7	32,7	25,2
1400	38,0	35,8	27,6
INPUT SPEED (rpm)	800	43,7	41,1
	400	51,9	48,9
	200	61,8	58,2
	100	73,4	69,2
	50	87,3	82,3

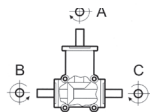

DISCOUNTS

Qty	1+	6+	20+	40+
Disc.	List	-15%	-20%	On request

Part number	Type	Ratio	Input	Output	Max. input speed (rpm)	Max. output speed (rpm)	Weight (kg)	Price each 1 to 5
CHTRP24-1-1	1	1:1	A	B	3000	3000	4,5	388,64 €
CHTRP24-2-1	2	1:1	A	C	3000	3000	4,5	667,13 €
CHTRP24-3-2	3	2:1	A	B	3000	1500	4,5	437,31 €
CHTRP24-4-2	4	2:1	A	C	3000	1500	4,5	437,31 €
CHTRP24-5-3	5	3:1	A	B	3000	1000	4,5	470,68 €
CHTRP24-6-3	6	3:1	A	C	3000	1000	4,5	470,70 €
CHTRP24-7-1	7	1:1	A	B-C	3000	3000	4,5	427,83 €
CHTRP24-8-2	8	2:1	A	B-C	3000	1500	4,5	463,50 €
CHTRP24-9-3	9	3:1	A	B-C	3000	1000	4,5	510,41 €

Depending of availability - Dimensions in mm

Our other products



KSM

Cylindrical steel nut,
Steel - 1 thread

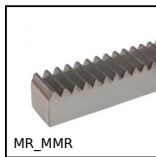

MR_MMR

Metric section rack,
Steel



PPD

Indexing plunger for
sheets, For sheet
metal



E15

Right angle helical
reducers, from 0.40 to
2.53 Nm



SSHBRA

Stainless steel bevel
gear, 1,5:1 2:1 3:1



E50

Right angle helical
reducers, from 3 to 41
Nm



CHA60

Rectangular hinge,
drilled or countersunk,
Rectangular, drilled or
C...



UCP_PBT

Stainless/Polymer
pillow block bearing,
Polymer and stainless
steel



PO

Pull handle - Multi-
sector, Tapped



GPB

Threaded spherical
knob, With brass



EIM

Stainless steel U bolt,
Stainless steel



CHAsb28

Roll of hinge without
pin, Plastic hinge

Complementary products



BLH20

Right angled gearbox,
from 0.53 to 1.77



BLHT20

Right angled gearbox,
from 0.66 to 1.77 Nm



BLHT30

Right angled gearbox,
from 1.65 to 4.40 Nm