



# Single and dual output gearboxes

Torque up to 4.7Nm

CHTRB8

- Gearbox with one or two outputs
- Ratios from 1:1 to 2:1
- Maximum speed 3,000 rpm
- Lubrication: Synthetic oil
- Material :
  - Housing: Cast aluminium
  - Gears: Steel 16CrN4
- Operating temperature -20° to +80°C

## Info.

- Max. axial load : 210N
- Max. radial load at 7,5mm : 110N
- If used as a multiplier, the maximum input speed is 750 rpm for gearboxes with a 2:1 ratio.

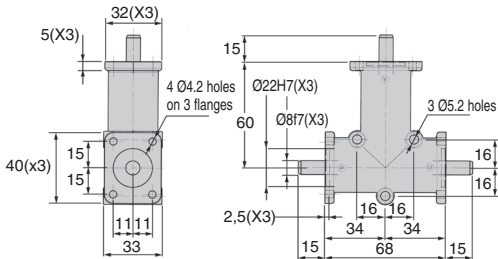

## OUTPUT TORQUE (Nm: VALUES GIVEN AS A GUIDE ONLY)

Ratios	1:1	2:1
3000	1,7	1,4
2000	1,8	1,6
1400	2,0	1,7
800	2,3	2,0
400	2,8	2,4
200	3,3	2,8
100	3,9	3,4
50	4,7	4,0

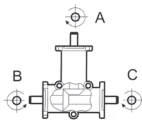

## DISCOUNTS

Qty	1+	2+	4+
Disc.	List -15%		On request

Part number	Type	Ratio	Input	Output	Max. input	Max. output	Weight (kg)	Stock*	Price each
					speed (rpm)	speed (rpm)			
CHTRB8-1-1	1	1:1	A	B	3000	3000	0,3	✓	155,45 €
CHTRB8-2-1	2	1:1	A	C	3000	3000	0,3	✓	155,45 €
CHTRB8-3-2	3	2:1	A	B	3000	1500	0,3	✓	155,45 €
CHTRB8-4-2	4	2:1	A	C	3000	1500	0,3	-	155,45 €
CHTRB8-5-1	5	1:1	A	B-C	3000	3000	0,3	✓	163,36 €
CHTRB8-6-2	6	2:1	A	B-C	3000	1500	0,3	-	163,36 €

Depending of availability - Dimensions in mm

# Single and dual output gearboxes

## CHTRB15

## Torque up to 16.5Nm

- Gearbox with one or two outputs
- Ratios from 1:1 to 2:1
- Maximum speed 3,000 rpm
- Lubrication: Synthetic oil
- Material :
  - Housing: Cast aluminium
  - Gears: Steel 16CrN4
- Operating temperature -20° to +80°C

### Info.

- Max. axial load : 410N
- Max. radial load at 17,5mm : 200N
- If used as a multiplier, the maximum input speed is 750 rpm for gearboxes with a 2:1 ratio.

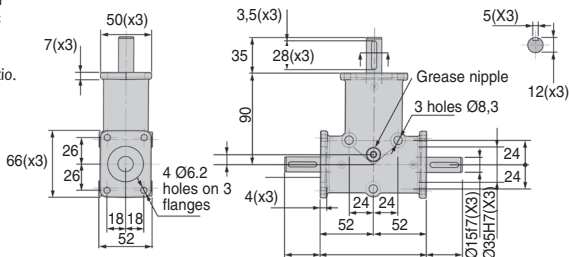
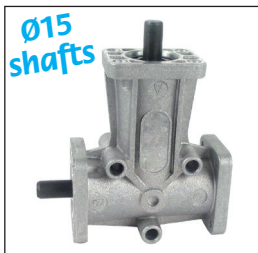

### OUTPUT TORQUE (Nm: VALUES GIVEN AS A GUIDE ONLY)

Ratios		1:1	2:1
INPUT SPEED (rpm)	3000	5,9	5,2
	2000	6,6	5,8
	1400	7,2	6,3
	800	8,2	7,3
	400	9,8	8,7
	200	11,7	10,3
	100	13,9	12,3
	50	16,5	14,6

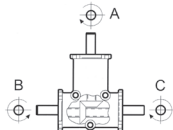

### DISCOUNTS

Qty	1+	2+	4+
Disc.	List -15%	On request	On request

Part number	Type	Ratio	Input	Output	Max. input speed (rpm)	Max. output speed (rpm)	Weight (kg)	Price each
CHTRB15-1-1	1	1:1	A	B	3000	3000	1,1	202,35 €
CHTRB15-2-1	2	1:1	A	C	3000	3000	1,1	202,35 €
CHTRB15-3-2	3	2:1	A	B	3000	1500	1,1	202,35 €
CHTRB15-4-2	4	2:1	A	C	3000	1500	1,1	202,35 €
CHTRB15-5-1	5	1:1	A	B-C	3000	3000	1,2	211,02 €
CHTRB15-6-2	6	2:1	A	B-C	3000	1500	1,2	211,02 €

Depending of availability - Dimensions in mm



# Single and dual output gearboxes

## Torque up to 53.1Nm

## CHTRB20

- Gearbox with one or two outputs
- Ratios from 1:1 to 2:1
- Maximum speed 3,000 rpm
- Lubrication: Synthetic oil
- Material:
  - Housing: Cast aluminium
  - Gears: Steel 16CrN4
- Operating temperature -20° to +80°C

### Info.

- Max. axial load : 760N
- Max. radial load at 25mm : 430N
- If used as a multiplier, the maximum input speed is 750 rpm for gearboxes with a 2:1 ratio.

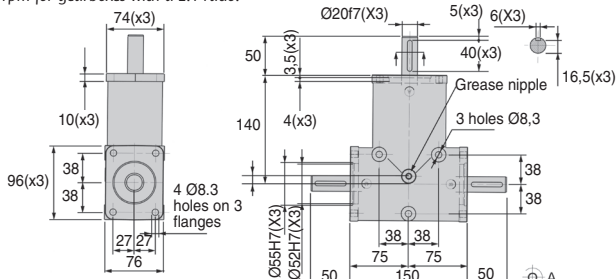

### OUTPUT TORQUE (Nm: VALUES GIVEN AS A GUIDE ONLY)

Ratios	1:1	2:1
3000	19,1	15,3
2000	21,1	16,9
1400	23,1	18,5
INPUT SPEED (rpm)		
800	26,5	21,3
400	31,6	25,3
200	37,5	30,1
100	44,6	35,7
50	53,1	42,5

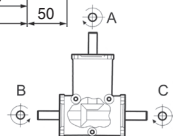

### DISCOUNTS

Qty	1+	2+	4+
Disc.	List -15%	On request	On request

Part number	Type	Ratio	Input	Output	Max. input	Max. output	Weight (kg)	Stock*	Price each
					speed (rpm)	speed (rpm)			
CHTRB20-1-1	1	1:1	A	B	3000	3000	3,4	✓	287.53 €
CHTRB20-2-1	2	1:1	A	C	3000	3000	3,4	-	287.53 €
CHTRB20-3-2	3	2:1	A	B	3000	1500	3,4	-	287.53 €
CHTRB20-4-2	4	2:1	A	C	3000	1500	3,4	✓	287.53 €
CHTRB20-5-1	5	1:1	A	B-C	3000	3000	3,5	✓	292.13 €
CHTRB20-6-2	6	2:1	A	B-C	3000	1500	3,5	✓	292.13 €

Depending of availability - Dimensions in mm

# Single and dual output gearboxes

## CHTRB25

## Torque up to 87.3Nm

- Gearbox with one or two outputs
- Ratios from 1:1 to 2:1
- Maximum speed 3,000 rpm
- Lubrication: Synthetic oil
- Material:
  - Housing: Cast aluminium
  - Gears: Steel 16CrN4
- Operating temperature -20° to +80°C

### Info.

- Max. axial load : 880N
- Max. radial load at 35mm : 490N
- If used as a multiplier, the maximum input speed is 750 rpm for gearboxes with a 2:1 ratio.

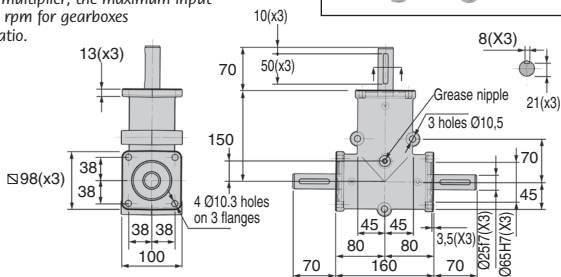

### OUTPUT TORQUE (Nm: VALUES GIVEN AS A GUIDE ONLY)

Ratios		1:1	2:1
INPUT SPEED (rpm)	3000	31,4	29,6
	2000	34,7	32,7
	1400	38,0	35,8
	800	43,7	41,1
	400	51,9	48,9
	200	61,8	58,2
	100	73,4	69,2
	50	87,3	82,3

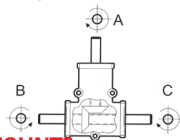

### DISCOUNTS

Qty	1+	2+	4+
Disc.	List	-15%	On request

Part number	Type	Ratio	Input	Output	Max. input speed (rpm)	Max. output speed (rpm)	Weight (kg)	Price each
CHTRB25-1-1	1	1:1	A	B	3000	3000	5,5	356.67 €
CHTRB25-2-1	2	1:1	A	C	3000	3000	5,5	356.67 €
CHTRB25-3-2	3	2:1	A	B	3000	1500	5,5	356.67 €
CHTRB25-4-2	4	2:1	A	C	3000	1500	5,5	356.67 €
CHTRB25-5-1	5	1:1	A	B-C	3000	3000	5,8	369.52 €
CHTRB25-6-2	6	2:1	A	B-C	3000	1500	5,8	369.52 €

Dimensions in mm



# Single and dual output gearboxes

Torque up to 9.1Nm

CHTRP8

- Gearbox with one or two outputs
- Ratios from 1:1 to 2:1
- Maximum speed 3,000 rpm
- Lubrication: Synthetic oil
- Material:
  - Housing: Cast aluminium
  - Gears: Steel 16CrN4
- Operating temperature -20° to +80°C

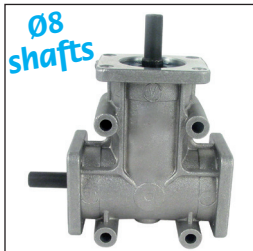

## Info.

- Max. axial load : 280N
- Max. radial load at 10mm : 150N
- If used as a multiplier, the maximum input speed is 750 rpm for gearboxes with a 2:1 ratio.

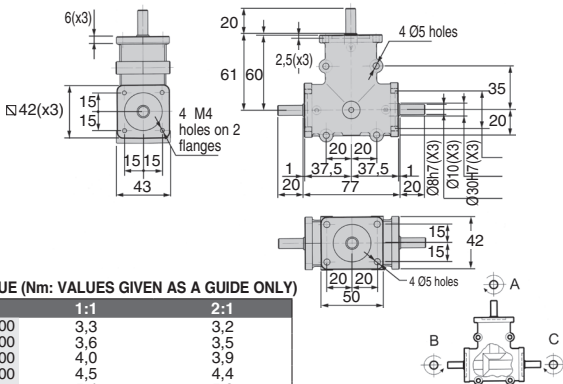

## OUTPUT TORQUE (Nm: VALUES GIVEN AS A GUIDE ONLY)

Ratios	1:1	2:1
3000	3,3	3,2
2000	3,6	3,5
1400	4,0	3,9
800	4,5	4,4
400	5,4	5,3
200	6,4	6,3
100	7,6	7,5
50	9,1	8,9

## DISCOUNTS

Qty	1+	6+	20+	40+
Disc.	List	-15%	-20%	On request

Part number	Type	Ratio	Input	Output	Max. input speed (rpm)	Max. output speed (rpm)	Weight (kg)	Price each
CHTRP8-1-1	1	1:1	A	B	3000	3000	0,6	213,79 €
CHTRP8-2-1	2	1:1	A	C	3000	3000	0,6	213,79 €
CHTRP8-3-2	3	2:1	A	B	3000	1500	0,6	241,47 €
CHTRP8-4-2	4	2:1	A	C	3000	1500	0,6	241,49 €
CHTRP8-5-1	5	1:1	A	B-C	3000	3000	0,6	226,61 €
CHTRP8-6-2	6	2:1	A	B-C	3000	1500	0,6	256,35 €

Depending of availability - Dimensions in mm

# Single and dual output gearboxes

## CHTRP14

**Torque up to 34.5Nm**

- Gearbox with one or two outputs
- Ratios from 1:1 to 3:1
- Maximum speed 3,000 rpm
- Lubrication: Synthetic oil
- Material:
  - Housing: Cast aluminium
  - Gears: Steel 16CrN4
- Operating temperature -20° to +80°C

### Info.

- Max. axial load : 530N
- Max. radial load at 15mm : 300N
- If used as a multiplier, the maximum input speed is 750 rpm for gearboxes with a 2:1 ratio and 500 rpm for a 3:1 ratio.

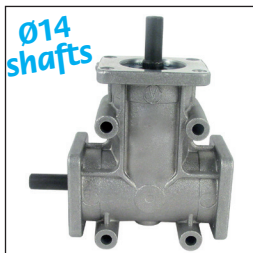
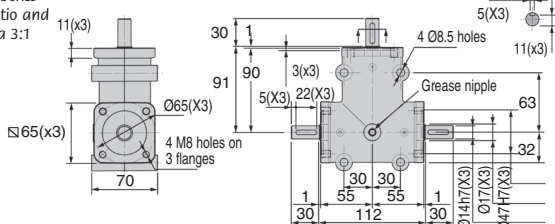

### OUTPUT TORQUE (Nm: VALUES GIVEN AS A GUIDE ONLY)

Ratios		1:1	2:1	3:1
INPUT SPEED (rpm)	3000	12,4	12,2	9,9
	2000	13,7	13,5	10,9
	1400	15,0	14,7	12,0
	800	17,2	16,9	13,7
	400	20,5	20,1	16,3
	200	24,4	23,9	19,4
	100	29,0	28,5	23,1
	50	34,5	33,8	27,5

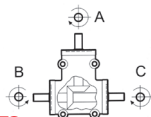

### DISCOUNTS

Qty	1+	6+	20+	40+
Disc.	List	-15%	-20%	On request

Part number	Type	Ratio	Input	Output	Max. input speed (rpm)	Max. output speed (rpm)	Weight (kg)	Price each	
								Stock*	1 to 5
CHTRP14-1-1	1	1:1	A	B	3000	3000	2	✓	259.02 €
CHTRP14-2-1	2	1:1	A	C	3000	3000	2	✓	259.02 €
CHTRP14-3-2	3	2:1	A	B	3000	1500	2	✓	277.83 €
CHTRP14-4-2	4	2:1	A	C	3000	1500	2	✓	277.83 €
CHTRP14-5-3	5	3:1	A	B	3000	1000	2	✓	284.23 €
CHTRP14-6-3	6	3:1	A	C	3000	1000	2	✓	284.23 €
CHTRP14-7-1	7	1:1	A	B-C	3000	3000	2	✓	284.23 €
CHTRP14-8-2	8	2:1	A	B-C	3000	1500	2	✓	297.53 €
CHTRP14-9-3	9	3:1	A	B-C	3000	1000	2	✓	319.71 €

Depending of availability - Dimensions in mm



# Single and dual output gearboxes

## Torque up to 28.8Nm

## CHTRP14

- Gearbox with one or two outputs
- Ratios from 1:1 to 3:1
- Maximum speed 3,000 rpm
- Lubrication: Synthetic oil
- Material:
  - Housing: Cast aluminium
  - Gears: Steel 16CrN4
- Operating temperature -20° to +80°C

Ø14 hollow output shaft

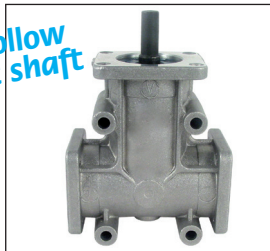

### Info.

- Max. axial load : 530N
- Max. radial load at 15mm : 300N
- If used as a multiplier, the maximum input speed is 750 rpm for gearboxes with a 2:1 ratio and 500 rpm for a 3:1 ratio.

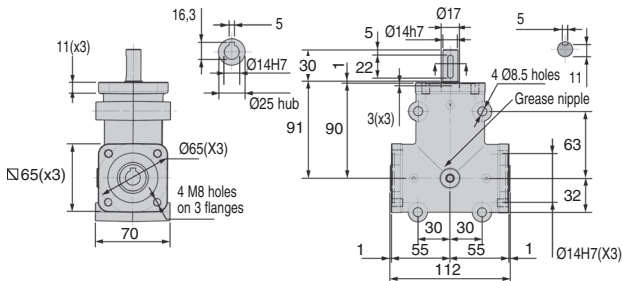

### OUTPUT TORQUE (Nm: VALUES GIVEN AS A GUIDE ONLY)

Ratios	1:1	2:1	3:1
3000	10,3	10,1	9,9
2000	11,4	11,2	10,9
1400	12,5	12,2	12,0
800	14,4	14,1	13,7
400	17,1	16,7	16,3
200	20,3	19,9	19,4
100	24,2	23,7	23,1
50	28,8	28,1	27,5

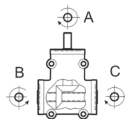

### DISCOUNTS

Qty	1+	6+	20+	40+
Disc.	List	-15%	-20%	On request

Part number	Type	Ratio	Input	Output	Max. input speed (rpm)	Max. output speed (rpm)	Weight (kg)	Price each 1 to 5
CHTRP14-10-1	10	1:1	A	B-C	3000	3000	2	325.84 €
CHTRP14-11-2	11	2:1	A	B-C	3000	1500	2	351.98 €
CHTRP14-12-3	12	3:1	A	B-C	3000	1000	2	379.13 €

Depending of availability - Dimensions in mm

# Single and dual output gearboxes

## CHTRP19

## Torque up to 87.3Nm

- Gearbox with one or two outputs
- Ratios from 1:1 to 3:1
- Maximum speed 3,000 rpm
- Lubrication: Synthetic oil
- Material:
  - Housing: Cast aluminium
  - Gears: Steel 16CrN4
- Operating temperature -20° to +80°C

### Info.

- Max. axial load : 650N
- Max. radial load at 20mm : 450N
- If used as a multiplier, the maximum input speed is 750 rpm for gearboxes with a 2:1 ratio and 500 rpm for a 3:1 ratio.

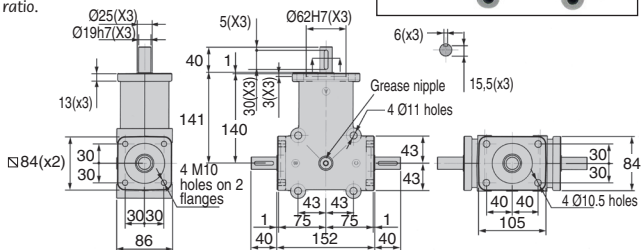
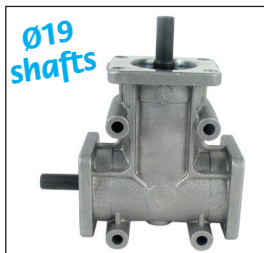

### OUTPUT TORQUE (Nm: VALUES GIVEN AS A GUIDE ONLY)

Ratios	1:1	2:1	3:1
3000	31,4	29,6	22,8
2000	34,7	32,7	25,2
1400	38,0	35,8	27,6
INPUT SPEED (rpm)			
800	43,7	41,1	31,7
400	51,9	48,9	37,7
200	61,8	58,2	44,9
100	73,4	69,2	53,3
50	87,3	82,3	63,4

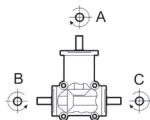

### DISCOUNTS

Qty	1+	6+	20+	40+
Disc.	List	-15%	-20%	On request

Part number	Type	Ratio	Input	Output	Max. input speed (rpm)	Max. output speed (rpm)	Weight (kg)	Stock*	Price each
									1 to 5
CHTRP19-1-1	1	1:1	A	B	3000	3000	4,5	✓	379,01 €
CHTRP19-2-1	2	1:1	A	C	3000	3000	4,5	-	379,01 €
CHTRP19-3-2	3	2:1	A	B	3000	1500	4,5	-	396,87 €
CHTRP19-4-2	4	2:1	A	C	3000	1500	4,5	-	396,85 €
CHTRP19-5-3	5	3:1	A	B	3000	1000	4,5	✓	414,85 €
CHTRP19-6-3	6	3:1	A	C	3000	1000	4,5	-	414,89 €
CHTRP19-7-1	7	1:1	A	B-C	3000	3000	4,5	✓	378,89 €
CHTRP19-8-2	8	2:1	A	B-C	3000	1500	4,5	-	402,52 €
CHTRP19-9-3	9	3:1	A	B-C	3000	1000	4,5	✓	431,67 €

Depending of availability - Dimensions in mm





# Single and dual output gearboxes

Torque up to 75.7Nm

CHTRP19

- Gearbox with one or two outputs
- Ratios from 1:1 to 3:1
- Maximum speed 3,000 rpm
- Lubrication: Synthetic oil
- Material:
  - Housing: Cast aluminium
  - Gears: Steel 16CrN4
- Operating temperature -20° to +80°C

Ø19 hollow output shafts

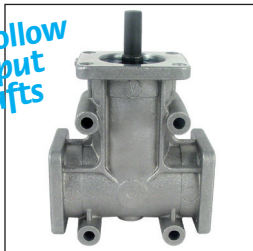

## Info.

- Max. axial load : 650N
- Max. radial load at 20mm : 450N
- If used as a multiplier, the maximum input speed is 750 rpm for gearboxes with a 2:1 ratio and 500 rpm for a 3:1 ratio.

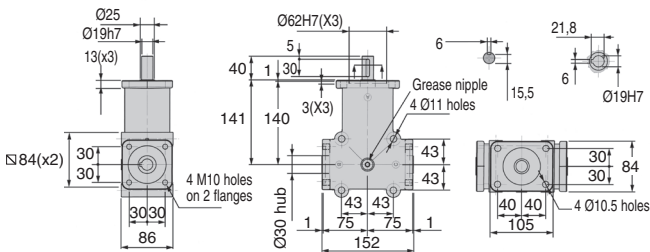

## OUTPUT TORQUE (Nm: VALUES GIVEN AS A GUIDE ONLY)

Ratios	1:1	2:1	3:1
3000	27,2	26,6	22,8
2000	30,1	28,3	25,2
1400	32,9	31,0	27,6
800	37,9	35,6	31,7
400	45,0	42,4	37,7
200	53,5	50,4	44,9
100	63,7	59,9	53,3
50	75,7	71,3	63,4

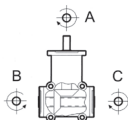

## DISCOUNTS

Qty	1+	6+	20+	40+
Disc.	List	-15%	-20%	On request

Part number	Type	Ratio	Input	Output	Max. input speed (rpm)	Max. output speed (rpm)	Weight (kg)	Price each 1 to 5
CHTRP19-10-1	10	1:1	A	B-C	3000	3000	4,5	489,85 €
CHTRP19-11-2	11	2:1	A	B-C	3000	1500	4,5	578,90 €
CHTRP19-12-3	12	3:1	A	B-C	3000	1000	4,5	667,13 €

Depending of availability - Dimensions in mm

# Single and dual output gearboxes

## CHTRP24

## Torque up to 87.3Nm

- Gearbox with one or two outputs
- Ratios from 1:1 to 3:1
- Maximum speed 3,000 rpm
- Lubrication: Synthetic oil
- Material:
  - Housing: Cast aluminium
  - Gears: Steel 16CrN4
- Operating temperature -20° to +80°C

### Info.

- Max. axial load : 800N
- Max. radial load at 25mm : 600N
- If used as a multiplier, the maximum input speed is 750 rpm for gearboxes with a 2:1 ratio and 500 rpm for a 3:1 ratio.

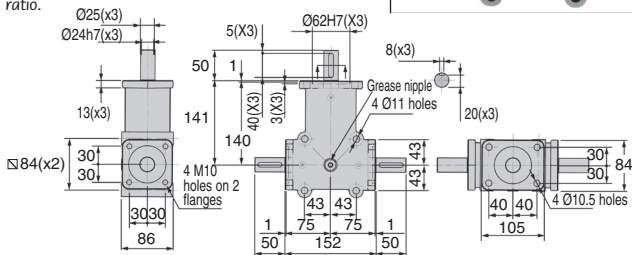
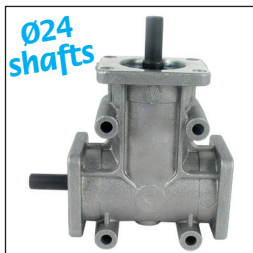

### OUTPUT TORQUE (Nm: VALUES GIVEN AS A GUIDE ONLY)

Ratios	1:1	2:1	3:1
3000	31,4	29,6	22,8
2000	34,7	32,7	25,2
1400	38,0	35,8	27,6
INPUT SPEED (rpm)	800	43,7	41,1
400	51,9	48,9	37,7
200	61,8	58,2	44,9
100	73,4	69,2	53,3
50	87,3	82,3	63,4

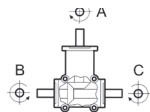

### DISCOUNTS

Qty	1+	6+	20+	40+
Disc.	List	-15%	-20%	On request

Part number	Type	Ratio	Input	Output	Max. input speed (rpm)	Max. output speed (rpm)	Weight (kg)	Price each 1 to 5
CHTRP24-1-1	1	1:1	A	B	3000	3000	4,5	388,64 €
CHTRP24-2-1	2	1:1	A	C	3000	3000	4,5	667,13 €
CHTRP24-3-2	3	2:1	A	B	3000	1500	4,5	437,31 €
CHTRP24-4-2	4	2:1	A	C	3000	1500	4,5	437,31 €
CHTRP24-5-3	5	3:1	A	B	3000	1000	4,5	470,68 €
CHTRP24-6-3	6	3:1	A	C	3000	1000	4,5	470,70 €
CHTRP24-7-1	7	1:1	A	B-C	3000	3000	4,5	427,83 €
CHTRP24-8-2	8	2:1	A	B-C	3000	1500	4,5	463,50 €
CHTRP24-9-3	9	3:1	A	B-C	3000	1000	4,5	510,41 €

Depending of availability - Dimensions in mm

## Our other products



BLHB50

Right angled gearbox, bored shafts, up to 30 Nm



BOX-SHNA

Hexagonal nut - DIN934, Box set of steel nuts



AT5P\_AT10P

Connecting plate for AT type timing belts, AT10



UCFL\_SS

Stainless steel flanged bearing, Stainless steel



CHAupa

Front hinge, 270°



JCDss

Double universal joint - Stainless steel, Low duty



NSU

Universal 90° support clamp, Universal 90° support clamp



HCA

Magnetic screw with socket, Steel



HTD14M\_85

HTD Heavy duty timing pulley, HTD14 Cast

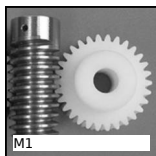

M1

Worm and wheel set, Machined plastic (delrin)



VBFP

Small 6 lobe threaded handle - female, Duroplast - Stainless



VBFP

Small 6 lobe threaded handle - female, Duroplast - Brass

## Complementary products



BLH20

Right angled gearbox, from 0.53 to 1.77



BLHT20

Right angled gearbox, from 0.66 to 1.77 Nm



BLHT30

Right angled gearbox, from 1.65 to 4.40 Nm