

Miniature ballscrew and nut

BSPM

Rolled ballscrew diameters from 6 to 14mm

- **Rolled ballscrew, precision class 7**
- Max axial backlash : 0.05mm
- **Supplied with the nut flange** to the left
- Machined to be compatible with **BEK** bearings (Fig A) and **BEF** bearings (Fig B). No keyway.
- Screw manufactured from steel

Options

- Shorter lengths available on request
- Nut with flange on right

Info

- This part number includes 1 ballscrew and 1 nut

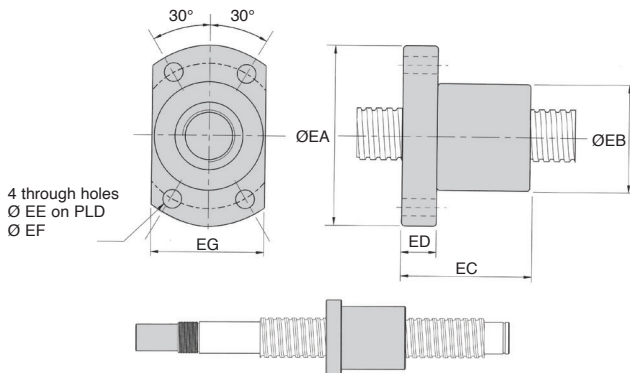
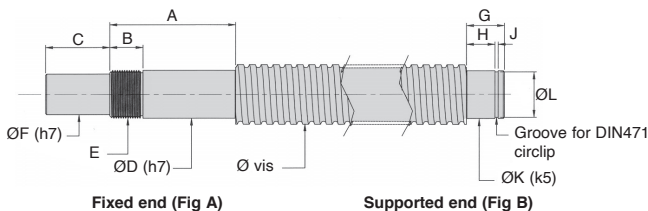

Dimensions in mm

- Basic nut, precision class 7
- Nut has no lubrication point

Info

- Not available separately
- Do not disassemble
- Delivered non lubricated, user should apply lubricant before use.

Accessories

- Bearing housing
BEF (tome 3 p.336) and
BEK (tome 3 p.337)

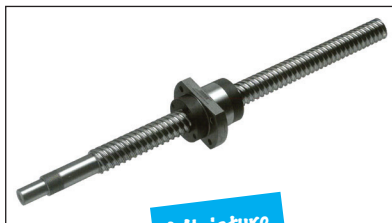

Miniature

DISCOUNTS

Qty	1+	2+	5+
Disc.	List	-5%	On request

Part number	A	B	C	D	E	F	G	H	J	K	L
BSPM0601R-150	Drawing supplied by the user										
BSPM0801R-200	29	9	8	6	M6x0,75	4	9	6	0,8	6	5,7
BSPM1002R-300	34	11	10	8	M8x1	6	9	6	0,8	6	5,7
BSPM1202R-600	38	13	15	10	M10x1	8	10	7	0,9	8	7,6
BSPM1402R-700	38	13	15	12	M12x1	10	10	7	0,9	8	7,6

Part number	ØScrew	Pitch	Max length	Length	Axial rigidity (N/µm)	Price each. 1 screw + 1 nut
BSPM0601R-150	6	1	900	150	55	On request
BSPM0801R-200	8	1	3000	200	72	520,92 €
BSPM1002R-300	10	2	3000	300	90	592,96 €
BSPM1202R-600	12	2	3000	600	110	712,11 €
BSPM1402R-700	14	2	3000	700	120	713,30 €

Part number for screw	ØScrew	Pitch	Load								Ca (kN)	Stat Coa (kN)	Not available separately
			EA	EB	EC	ED	EE	EF	EG	Dyn			
BSPM0601R-150	6	1	24	12	18	3,5	3,4	18	16	1,11	1,23		
BSPM0801R-200	8	1	27	14	20	4	3,4	21	18	1,26	1,62		
BSPM1002R-300	10	2	35	18	28	5	4,5	27	22	2,40	3,02		
BSPM1202R-600	12	2	37	20	28	5	4,5	29	24	2,65	3,77		
BSPM1402R-700	14	2	40	21	28	6	5,5	31	26	2,83	4,40		

Dimensions in mm

Bearing housing for **miniature** ballscrew

BEF

Non fixed end

- Bearing designed to receive the free end of a miniature ballscrew (refer to BSPM Fig B)
- Fitted with a deep groove ball bearing
- Material :
Blackened steel



Assembly

- Use the circlip supplied to block the axial position of the ballscrew

Info

- There is no product available for 6mm ballscrews

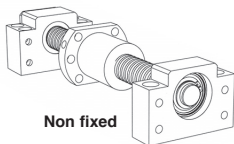
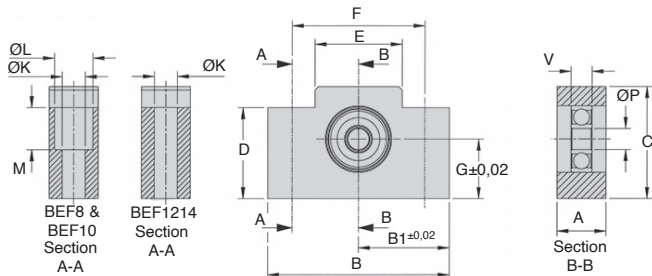

DISCOUNTS

Qty	1+	2+	5+
Disc.	List	-5%	On request

Part number	Screw Ø	A	B	B1	C	D	E	F	G
BEF8	8	14	42	21	25	20	18	30	13
BEF10	10	14	52	26	32	24	25	38	17
BEF1214	12 et 14	20	70	35	43	24	36	52	25

Part number	ØK	ØL	M	ØP	V	Bearing	Price each
BEF8	5,5	9,5	11	6	6	606ZZ	277,43 €
BEF10	6,6	11	12	6	6	606ZZ	277,43 €
BEF1214	9	-	-	8	7	608ZZ	277,43 €

Dimensions in mm

Bearing housing for **miniature** ballscrew

Fixed end

BEK

- Bearing designed to receive the fixed end of a miniature ballscrew (refer to BSPM Fig A)
- Fitted with 2 angular contact bearings
- Accurate radial and axial positioning of the ballscrew
- Material :
Blackened steel

Assembly

- Locking nut should be fully tightened and secured with the grub screw

Info

- There is no product available for 6mm ballscrews

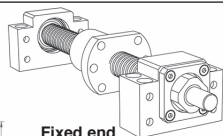
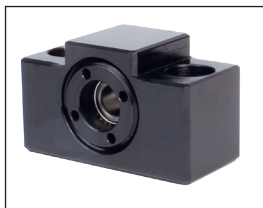

Fixed end

BEK12 & BEK14

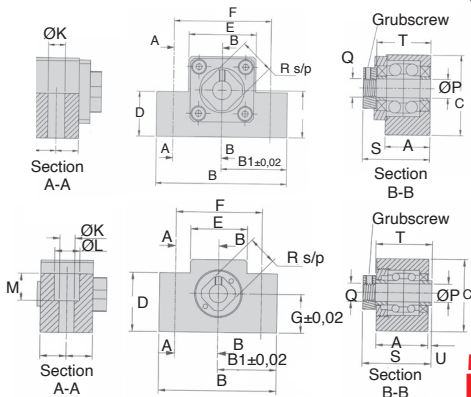

BEK8 & BEK10

DISCOUNTS

Qty	1+	2+	5+
Disc.	List	-5%	On request

Part number	Ø Screw	A	B	B1	C	D	E	F	G
BEK8	8	20	42	21	25	20	18	30	13
BEK10	10	23	52	26	32	24	25	38	17
BEK12	12	24	70	35	43	24	36	52	25
BEK14	14	24	70	35	43	24	36	52	25

Part number	Ø Screw	ØL	M	ØP	Q	R	S	T	U	Price each
BEK8	5,5	9,5	11	6	M6x0,75	12	27	22	1,5	460,30 €
BEK10	6,6	11	12	8	M8x1	14	31,3	25	1,3	434,08 €
BEK12	9	-	-	10	M10x1	16	35,4	27	-	421,15 €
BEK14	9	-	-	12	M12x1	19	35,3	27	-	434,08 €

Dimensions in mm