

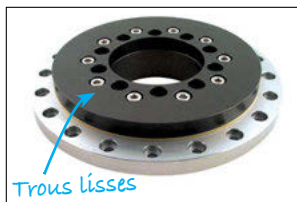

PRT

Avantages

- Exempt d'entretien
- Faible coefficient de frottement
- Économique
- Robuste
- Grande rigidité
- Montage facile
- Grande résistance à l'abrasion
- Matière :
 - Eléments de glissement : iglidur® J
 - Bague : aluminium EN AW 6061/6060 anodisé dur
 - Visserie : inox
- T° d'utilisation : de -50°C à +90°C



Basculement du PRT soumis à des forces excentrées

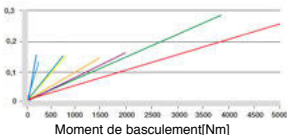

Couple nécessaire en cas de forces excentrées

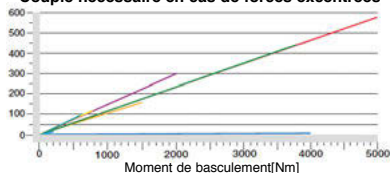

Couple nécessaire en cas de forces centrées

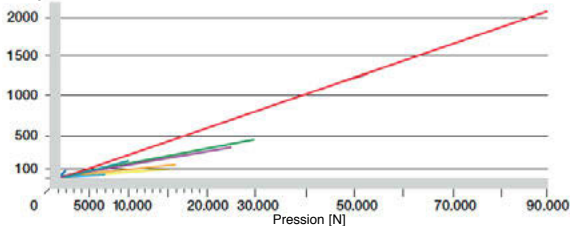

Références	Masse (kg)	Charge axiale maxi	Charge axiale maxi	Charge radiale maxi stat.	Charge radiale maxi stat.	Vitesse rotative max. à sec (1/mn)	Rigidité axiale (N/µm)	Rigidité radiale (N/µm)	Moment de basculement maxi admissible (Nm)			
		statique (N)	dynamique (N)	(N)	(N)				R1	R2	B	
PRT01-20	0,2	15 000	4 000	2 300	600	300	80	10	100	30	20	4,5
PRT01-30	0,4	27 000	7 000	5 000	1 500	250	100	50	200	41	29,0	4,5
PRT01-50	1,0	40 000	10 000	8 000	2 500	200	250	60	600	60	46,5	4,6
PRT01-60	1,1	50 000	15 000	10 000	3 000	200	300	65	800	65	51,5	4,5
PRT01-100	1,3	55 000	16 000	16 000	5 000	150	400	65	1 500	80	69,0	5,5
PRT01-150	2,2	80 000	25 000	25 000	8 000	100	450	65	2 000	110	96,5	5,5
PRT01-200	3,2	100 000	30 000	35 000	10 000	80	500	65	3 800	137	124,0	7,0

Dimensions en mm

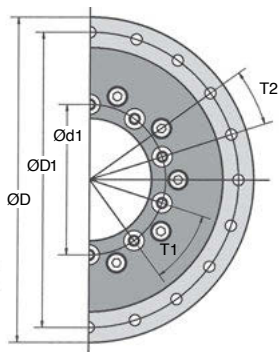
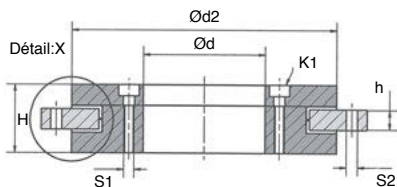
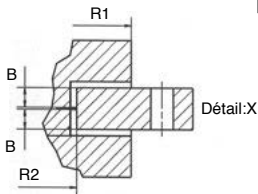
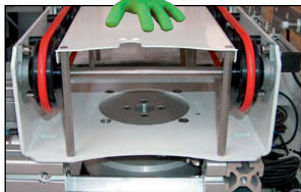
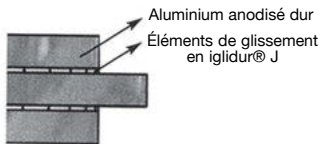

**NOUVELLES
REMISES**

REMISES

Qté	1+	2+
Rem.	Prix	Sur demande

Références	ØD	ØD1	Ød1	Ød	Ød2 ^{±0.2}	H	h	T1	T2	S1	S2	K1 pour Vis	Prix Uni.
PRT01-20	80	70	31	20	60	24	8	3 x 120°	6 x 60°	M4	4,5	DIN 7984 M4	182,51 €
PRT01-30	100	91	42,5	30	82	29	10	8 x 45°	8 x 45,0°	M4	4,5	DIN 7984 M4	202,16 €
PRT01-50	150	135	65	50	120	33	10	8 x 45°	16 x 22,5°	M6	6,6	ISO 4762 M6	279,38 €
PRT01-60	160	145	74,0	60	130	33	10	10 x 36°	20 x 18,0°	M5	5,5	DIN 912 M5	304,83 €
PRT01-100	185	170	112,0	100	160	34	12	12 x 30°	16 x 22,5°	M5	5,5	DIN 912 M5	562,52 €
PRT01-150	250	235	165	150	220	35	12	12 x 30°	16 x 22,5°	M6	5,5	ISO 4762 M5	778,72 €
PRT01-200	300	285	215,0	200	274	38	15	12 x 30°	16 x 22,5°	M6	7,0	DIN 912 M6	1 003,77 €

Dimensions en mm

Tél/ 0 825 88 5000
Service 0,15 € / min
+ prix appel

cial2@hpceurope.com

HPC

Tome ③ 2021

③ 405

Plateau tournant iglidur®

PRT

Avec denture extérieure

- Plateau tournant iglidur PRT avec anneau extérieur denté

- L'anneau intérieur est fixe, l'anneau extérieur qui est plus large porte le produit à transporter.

- Caractéristiques générales : voir plateaux PRT

- Matières :

Élément de glissement iglidur® J
Anneau aluminium EN AW 6061/6060
anodisé dur
Visserie inox

- 4 dentures possibles : engrenage selon DIN 3967, poulies T10, AT10 ou HTD8M

Denture engrenage ou poulie

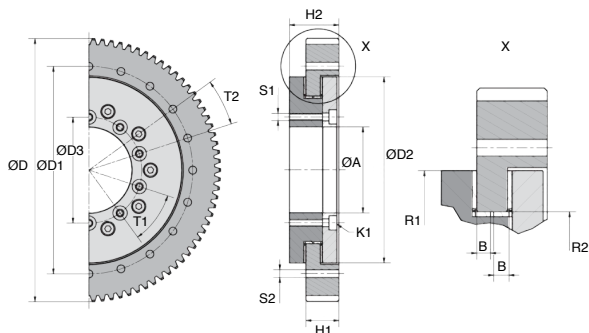
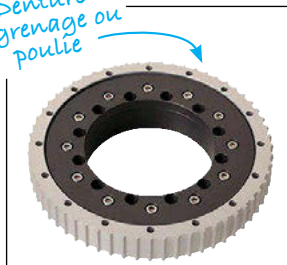

Références	ØD1	ØD3	ØA	ØD2	H1	T1	T2	S1	S2	K1 pour vis DIN 912				
										M4	M5	M6	M8	R1
PRT-01-30-TO	91	42,5	30	82	21	8x45°	8x45°	M4	4,5	M4	41	29,0	4,5	30,4
PRT-01-60-TO	145	74,0	60	130	23	10x36°	20x18°	M5	5,5	M5	65	51,5	4,5	34,5
PRT-01-100-TO	170	112,0	100	160	25	12x30°	16x22,5°	M5	5,5	M5	80	69,0	5,5	36,0
PRT-01-150-TO	235	165,0	150	220	25	12x30°	16x22,5°	M5	5,5	M5	110	96,5	5,5	37,5
PRT-01-200-TO	285	215,0	200	274	30	12x30°	16x22,5°	M6	7,0	M6	137	124,0	7,0	41,5
PRT-01-300-TO	430	320,0	300	410	30	12x30°	16x22,5°	M8	9,0	M8	205	186,5	8,5	46,5

Dimensions en mm



**Engrenage
DIN 3967**



**Poulie
AT10**

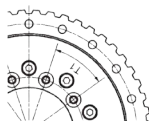

**Poulie
T10**



**Poulie
HTD8M**

**NOUVELLES
REMISES**

REMISES

Qté	1+	2+
Rem.	Prix	Sur demande

Références	Pas/module	Nb de dents Z	Diamètre primitif ØP	Diamètre extérieur ØD	Prix Uni.
Denture engrenage DIN 3967					
PRT01-30-TO-ST	2	54	108	112	571,66 €
PRT01-60-TO-ST	2	90	180	184	688,35 €
PRT01-100-TO-ST	2	96	192	196	1 006,95 €
PRT01-150-TO-ST	2	126	252	256	1 399,50 €
PRT01-200-TO-ST	2	152	304	308	1 760,83 €
PRT01-300-TO-ST	3	152	456	462	3 621,56 €
Denture poulie AT10					
PRT01-30-TO-AT10	AT10	34	108,23	108,23	571,68 €
PRT01-60-TO-AT10	AT10	52	165,52	165,52	688,35 €
PRT01-100-TO-AT10	AT10	60	187,30	187,30	1 006,95 €
PRT01-150-TO-AT10	AT10	80	250,90	250,90	1 399,50 €
PRT01-200-TO-AT10	AT10	96	301,90	301,90	1 760,83 €
PRT01-300-TO-AT10	AT10	144	352,85	352,85	3 621,56 €
Denture poulie T10					
PRT01-30-TO-T10	T10	34	108,23	106,40	571,66 €
PRT01-60-TO-T10	T10	52	165,52	163,80	688,35 €
PRT01-100-TO-T10	T10	60	187,30	189,20	1 006,95 €
PRT01-150-TO-T10	T10	80	250,90	252,90	1 399,50 €
PRT01-200-TO-T10	T10	96	301,90	303,90	1 760,83 €
PRT01-300-TO-T10	T10	144	352,85	456,70	3 621,56 €
Denture poulie HTD8M					
PRT01-30-TO-HTD8M	HTD8M	44	112,05	110,70	571,66 €
PRT01-60-TO-HTD8M	HTD8M	66	168,07	166,70	688,35 €
PRT01-100-TO-HTD8M	HTD8M	74	188,45	187,10	1 006,95 €
PRT01-150-TO-HTD8M	HTD8M	100	254,65	253,30	1 399,50 €
PRT01-200-TO-HTD8M	HTD8M	120	305,60	304,30	1 760,83 €
PRT01-300-TO-HTD8M	HTD8M	180	458,36	457,10	3 621,56 €

Dimensions en mm

0 825 88 5000
Service 0,15 € / min
+ prix appel