

High rigidity linear slide

Rail and slides

IKO LWH
LWH-C1H
LWHG-C1H

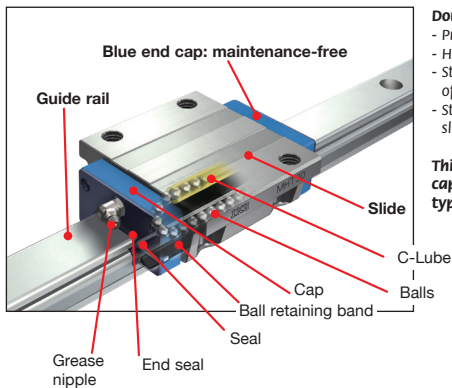

Double-row ball bearing slide

- Precision and stable rigidity
- High load capacity
- Stroke limited only by the length of the rails
- Standard or long interchangeable slides

This series has the highest load capacity and rigidity for a ball type.

Compose your guide by selecting the rail and the number of slides you need

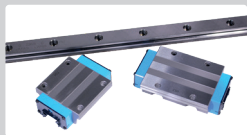

LWH-C1H slide

- Self-lubricating slide
- Slide length: standard
- Load capacity: normal

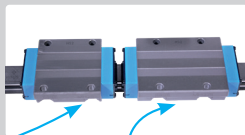

LWHG-C1H slide

- Long self-lubricating slide
- Slide length: long
- Load capacity: excellent

- Linear slide unit for heavy loads not subject to vibrations or shocks
- Recirculating ball type linear slide
- Standard accuracy
- Rails and slides units have separate part numbers, remember to order both
- Linear slide unit with steel balls
- Self-lubricating slide

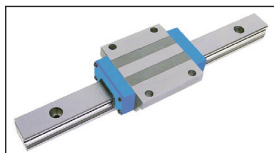

Application

- Machine tools

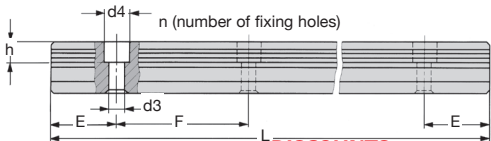

DISCOUNTS

Qty	1+	4+	8+
Disc.	List	-6%	On request

Part number	L	No. of holes	Max. length	Type of slide unit	Stock*	Price each 1 to 3
LWH15-180	180	3	1500	-	-	58.81 €
LWH15-240	240	4	1500	-	✓	78.43 €
LWH15-360	360	6	1500	-	✓	117.64 €
LWH15-480	480	8	1500	-	✓	156.86 €
LWH15-660	660	11	1500	-	-	215.69 €
LWH15-900	900	15	1500	-	-	294.12 €
LWH15-1200	1200	20	1500	-	-	392.16 €
LWH15-1500	1500	25	1500	-	-	490.21 €
LWH15-C1H	-	Slide	-	standard	✓	170.96 €
LWH20-240	240	4	1980	-	✓	83.97 €
LWH20-480	480	8	1980	-	✓	167.95 €
LWH20-660	660	11	1980	-	✓	230.93 €
LWH20-840	840	14	1980	-	✓	293.92 €
LWH20-1020	1020	17	1980	-	-	356.90 €
LWH20-1200	1200	20	1980	-	-	419.90 €
LWH20-1500	1500	25	1980	-	-	524.88 €
LWH20-1980	1980	33	1980	-	-	692.82 €
LWH20-C1H	-	Slide	-	standard	✓	190.50 €
LWH20G-C1H	-	Slide	-	long	-	243.12 €
LWH25-240	240	4	3000	-	✓	87.93 €
LWH25-480	480	8	3000	-	✓	175.87 €
LWH25-660	660	11	3000	-	✓	241.82 €
LWH25-840	840	14	3000	-	-	307.80 €
LWH25-1020	1020	17	3000	-	-	373.74 €
LWH25-1200	1200	20	3000	-	-	439.69 €
LWH25-1500	1500	25	3000	-	-	549.63 €
LWH25-1980	1980	33	3000	-	-	725.50 €
LWH25-3000	3000	50	3000	-	-	1 099.26 €
LWH25-C1H	-	Slide	-	standard	✓	214.59 €
LWH25G-C1H	-	Slide	-	long	✓	262.66 €

*Depending on availability - Dimensions in mm

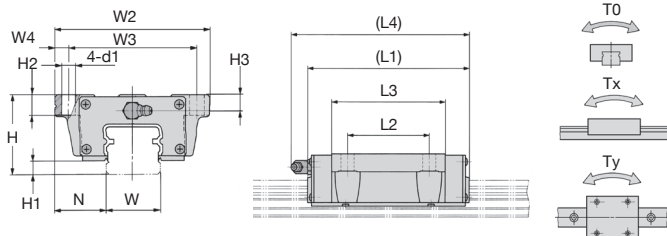

	LWH15-C1H	LWH20-C1H	LWH20G-C1H	LWH25-C1H	LWH25G-C1H
Weight (kg)					
Slide unit	0,22	0,48	0,71	0,70	0,93
Rail (per m)	1,47	2,56	2,56	3,50	3,50
Total dimensions					
H±0,04	24,00	30,00	30,00	36,00	36,00
H1	4,50	5,00	5,00	6,00	6,00
N±0,05	16,00	21,50	21,50	23,50	23,50
Slide dimensions					
W2	47,00	63,00	63,00	70,00	70,00
W3	38,00	53,00	53,00	57,00	57,00
W4	4,50	5,00	5,00	6,50	6,50
L1	66,00	83,00	112,00	95,00	118,00
L2	30,00	40,00	40,00	45,00	45,00
L3	44,60	57,50	86,00	64,70	87,40
L4	69,00	95,00	124,00	106,00	129,00
d1	4,50	6,00	6,00	7,00	7,00
H2	7,00	10,00	10,00	10,00	10,00
H3	4,50	5,50	5,50	6,50	6,50
Rail dimensions					
W	15,00	20,00	20,00	23,00	23,00
H4	15,00	18,00	18,00	22,00	22,00
d3	4,50	6,00	6,00	7,00	7,00
d4	8,00	9,50	9,50	11,00	11,00
h	6,00	8,50	8,50	9,00	9,00
E	30,00	30,00	30,00	30,00	30,00
F	60,00	60,00	60,00	60,00	60,00
Rail fixing screw	M4 x 16	M5 x 18	M5 x 18	M6 x 22	M6 x 22
Dynamic load					
C (N)	9320	14520	19030	20110	24320
Static load					
C ₀ (N)	14520	21875	32860	29820	39820
Static moment					
T ₀ (Nm)	116	240	360	375	500
T _x (Nm)	99	202	435	320	550
	575	1130	2200	1750	2845
T _y (Nm)	99	202	435	320	550
	575	1130	2200	1750	2845

Data given in row T0 and first rows of T_x and T_y are for a single slide

Dimensions in mm

Data given in second rows of T_x and T_y are for a two slides in close contact

- Linear slide unit for heavy loads not subject to vibrations or shocks
- Recirculating ball type linear slide
- Rails and slide units have separate part numbers, remember to order both
- Linear slide unit with steel balls
- Self-lubricating slide

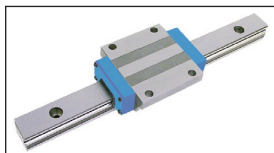

Application

- Machine tools

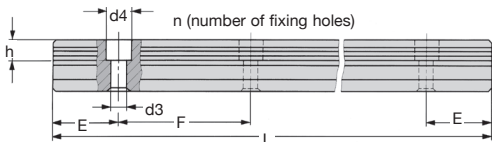
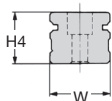

DISCOUNTS

Qty	1+	4+	8+
Disc. List	-6%	-6%	On request

Part number	L	No. of holes	Max. length	Type of slide unit	Stock*	Price each 1 to 3
LWH30-480	480	6	2960	-	-	210,74 €
LWH30-640	640	8	2960	-	-	280,98 €
LWH30-800	800	10	2960	-	-	351,23 €
LWH30-1040	1040	13	2960	-	-	456,60 €
LWH30-1200	1200	15	2960	-	-	526,85 €
LWH30-1520	1520	19	2960	-	-	667,35 €
LWH30-2000	2000	25	2960	-	-	878,09 €
LWH30-2960	2960	37	2960	-	-	1 299,57 €
LWH30-C1H	-	Slide	-	standard	-	243,12 €
LWH30G-C1H	-	Slide	-	long	-	315,26 €
LWH35-480	480	6	2960	-	-	285,20 €
LWH35-640	640	8	2960	-	-	380,29 €
LWH35-800	800	10	2960	-	-	543,81 €
LWH35-1040	1040	13	2960	-	-	617,96 €
LWH35-1200	1200	15	2960	-	-	713,03 €
LWH35-1520	1520	19	2960	-	-	903,18 €
LWH35-2960	2960	37	2960	-	-	1 758,83 €
LWH35-C1H	-	Slide	-	standard	-	334,93 €
LWH35G-C1H	-	Slide	-	long	-	440,06 €
LWH45-840	840	8	2940	-	-	582,31 €
LWH45-1050	1050	10	2940	-	-	727,89 €
LWH45-1260	1260	12	2940	-	-	873,47 €
LWH45-1470	1470	14	2940	-	-	1 019,04 €
LWH45-1995	1995	19	2940	-	-	1 383,00 €
LWH45-2940	2940	28	2940	-	-	2 038,10 €
LWH45-C1H	-	Slide	-	standard	-	445,16 €
LWH45G-C1H	-	Slide	-	long	-	605,56 €

*Depending on availability - Dimensions in mm

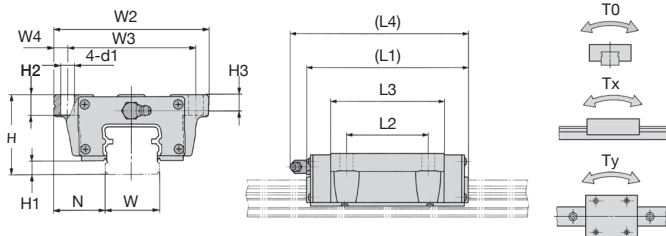

	LWH30-C1H	LWHG30-C1H	LWH35-C1H	LWHG35-C1H	LWH45-C1H	LWHG45-C1H
Weight (kg)						
Slide unit	1,28	1,69	1,78	2,35	3,17	4,34
Rail (per m)	4,82	4,82	6,85	6,85	10,70	10,70
Total dimensions						
H±0,04	42,00	42,00	48,00	48,00	60,00	60,00
H1	7,00	7,00	8,00	8,00	10,00	10,00
N±0,05	31,00	31,00	33,00	33,00	37,50	37,50
Slide dimensions						
W2	90,00	90,00	100,00	100,00	120,00	120,00
W3	72,00	72,00	82,00	82,00	100,00	100,00
W4	9,00	9,00	9,00	9,00	10,00	10,00
L1	113,00	139,00	123,00	151,00	147,00	190,00
L2	52,00	52,00	62,00	62,00	80,00	80,00
L3	80,60	106,60	86,20	114,00	103,40	146,60
L4	124,00	150,00	135,00	163,00	158,00	201,00
d1	9,00	9,00	9,00	9,00	12,00	12,00
H2	10,00	10,00	13,00	13,00	15,00	15,00
H3	8,00	8,00	10,00	10,00	13,00	13,00
Rail dimensions						
W	28,00	28,00	34,00	34,00	45,00	45,00
H4	25,00	25,00	28,00	28,00	34,00	34,00
d3	9,00	9,00	9,00	9,00	14,00	14,00
d4	14,00	14,00	14,00	14,00	20,00	20,00
h	12,00	12,00	12,00	12,00	17,00	17,00
E	40,00	40,00	40,00	40,00	52,50	52,50
F	80,00	80,00	80,00	80,00	105,00	105,00
Rail fixing screw	M8 x 28	M8 x 28	M8 x 28	M8 x 28	M12 x 35	M12 x 35
Dynamic load						
C (N)	28050	33550	37000	44920	56600	71300
Static load						
C ₀ (N)	42180	55230	55700	74260	83200	117720
Static moment						
T ₀ (Nm)	645	840	875	1165	1715	2430
T _x (Nm)	550	925	655	1125	1195	2320
	2900	4630	3610	5775	6425	11475
T _y (Nm)	550	925	600	1040	1098	2120
	2900	4630	3315	5300	5900	10500

Data given in row T₀ and first rows of T_x and T_y are for a single slide

Dimensions in mm

Data given in second rows of T_x and T_y are for a two slides in close contact

Accuracy

Accuracy of total assembly (mm)		
Tolerance on H		$\pm 0,020$
Tolerance on N ⁽³⁾		$\pm 0,025$
On 1	Variation on H ⁽¹⁾	0,007
total	Variation on N ⁽²⁾⁽³⁾	0,01
Variation on H for multiple units ⁽⁴⁾		0,025
Parallelism between C and A		See Fig. 1.
Parallelism entre D and B		See Fig. 1.

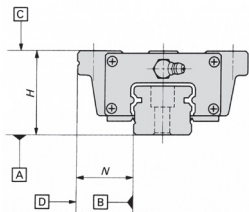

Note (1): This is the difference in the dimension H between two slide units mounted on the same track or on a pair of tracks when H is measured at a specified position.

Note (2): This is the difference in the dimension N between two slide units mounted on the same track or on a pair of tracks when N is measured at a specified position.

Note (3): These values also apply when the reference surfaces are assembled opposite each other.

Note (4): The difference in the dimension H for multiple assemblies represents the dimensional variation between the slide units of an arbitrary number of assemblies having the same accuracy class.

Note: All of the above are applicable only when the dimensions are measured at the centre of the slide unit mounted on a rail attached to a flat base.

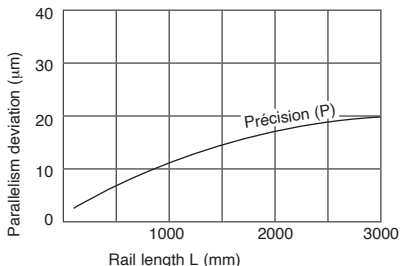

Fig.1 Working parallelism

Lubrication

These linear slide units are supplied lubricated with a Lithium soap based grease (Class 2) containing extreme pressure additives. A stoppered grease injector is supplied with each slide, this should be attached before use.

Assembly

To assemble LWH linear slide units, correctly position the assembly reference surfaces of the slide unit and rail on the reference surfaces of the table or frame and fasten securely.

Reference mounting surface

The reference side of the slide unit is the opposite side to the surface carrying the manufacturer's logo. In the same way, the reference side of the rail is that one opposite the upper surface which is marked with the manufacturer's logo.

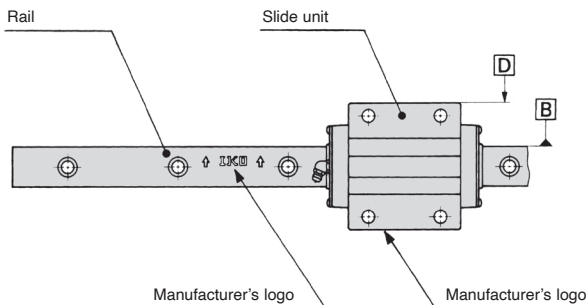

Fig.2 Assembly reference surfaces

Assembly recommendations

1- Manipulation

Every slide unit is supplied mounted on a dummy rail. When assembling the slide onto its guide rail, align the unit slots of the dummy rail with the guide rail and then move the slide unit on to the guide rail keeping the parts aligned correctly.

f_w : load factor (see table 1)

F_c : calculated theoretical load, N

2- Multiple slides units mounted side by side

Every slide unit is supplied mounted on a dummy rail. When assembling the slide unit onto its guide rail, align the units slots of the dummy rail with the guide rail and then move the slide unit on to the guide rail keeping the parts aligned correctly.

3- Example of multiple slide units mounted close together

Referring to Figure 3, the reference mounting surfaces **B** and **D** and mounting surfaces **A** and **C** of the LWH linear slides units have an accurately ground finish. Stable and high accurate linear motion will be obtained by finishing the mounting surfaces of machines or equipment to the same high accuracy and correctly mounting the guides on these surfaces.

It is recommended to machine a fillet at the corner of the mating reference mounting surfaces as shown in Fig. 4 . However, a radius smaller than R_1 of the slide unit or smaller than R_2 of the rail (see table 1) is also possible.

The heights of flanges on assembly reference surfaces are also given in table 1.

Fig.3 : Typical assembly

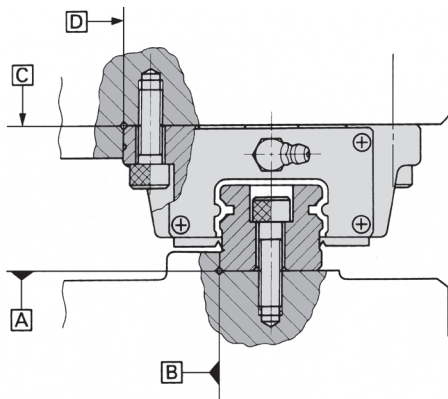
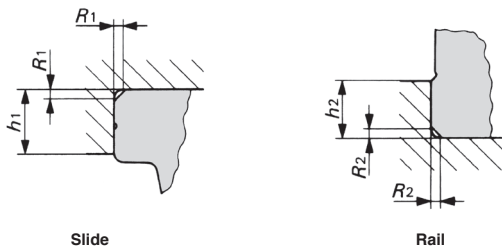

Table 1 : Accuracy



Part number	Slide unit		Rail	
	Radius R ₁ (max.)	Height of flange h ₁	Radius R ₂ (max.)	Height of flange h ₂
LWH15	0,5	4	0,5	0,5
LWH20	0,5	5	0,5	0,5
LWH25	1,0	6	1,0	1,0
LWH30	1,0	8	1,0	1,0
LWH35	1,0	8	1,0	1,0
LWH45	1,5	8	1,7	1,7

Note : These values apply to all types of slide units

4- Mounting bolt tightening torque

Table 2 gives the tightening torque of fastening bolts in normal use.

Table 2 : Mounting bolt tightening torque

Bolt dimensions	Locking torque (Nm)
M4 x 0,7	40
M5 x 0,8	80
M6 x 1	130
M8 x 1,25	320
M10 x 1,5	640
M12 x 1,75	1100

5- Working temperature

The normal continuous operating temperature of the LWL linear slide units is 100°C with occasional use at up to 120°C. If your application will exceed 100°C, please contact us for advice.