

Pignon à chaîne



PAS 4mm

Inox

- Pas 4mm
- Diam. rouleau 2,50mm
- Matière :

Inox (303)
Z10CNF 18,09

Accessoire

- Chaîne réf. SUA-4 (tome 4 p.122)

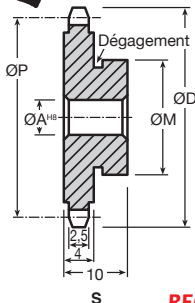

Le plus petit



REMISES

Qté	1+	6+	20+	50+
Rem.	Prix	-5%	-10%	Sur demande

Références	Z Dents	ØP	ØD	ØM	ØA	Dégagement Ø x largeur	Prix Uni. 1 à 5 S AS
S 4-10	10	12,94	14,71	12	4	8,00 x 2,5	18,98 €
S 4-11	11	14,20	16,02	12	4	8,00 x 2,5	20,16 €
S 4-12	12	15,45	17,32	12	4	8,00 x 2,5	21,18 €
S 4-13	13	16,71	18,62	12	4	9,05 x 2,5	22,24 €
S 4-14	14	17,97	19,92	12	4	10,33 x 2,5	24,12 €
S 4-15	15	19,23	21,21	12	4	11,60 x 2,5	24,71 €
S 4-16	16	20,50	22,50	12	4	-	26,25 €
S 4-17	17	21,76	23,79	12	4	-	28,43 €
S 4-18	18	23,06	25,08	12	4	-	29,67 €
S 4-19	19	24,29	26,37	12	4	-	31,01 €
S 4-20	20	25,57	27,65	15	5	-	32,45 €
S 4-21	21	26,83	28,94	15	5	-	33,81 €
S 4-23	23	29,37	31,50	15	5	-	35,22 €
S 4-25	25	31,91	34,06	15	5	-	36,59 €
S 4-27	27	34,45	36,62	15	5	-	39,93 €
S 4-30	30	38,26	40,45	15	5	-	44,56 €
S 4-33	33	42,08	44,29	15	5	-	46,96 €
S 4-35	35	44,62	46,84	15	5	-	48,29 €
S 4-36	36	45,89	48,12	15	5	-	49,62 €
S 4-38	38	48,43	50,67	15	5	-	49,98 €
S 4-40	40	50,98	53,22	20	6	-	50,34 €
S 4-42	42	53,52	55,77	20	6	-	50,54 €
S 4-44	44	56,07	58,32	20	6	-	51,00 €
S 4-48	48	61,12	63,42	20	6	-	51,47 €
S 4-50	50	63,66	65,98	20	6	-	51,94 €
S 4-60	60	76,39	78,72	20	6	-	54,00 €
S 4-80	80	101,86	104,20	20	6	-	167,37 €

Sur demande

Dimensions en mm

Acier C45

DIN 04-1
6mm

Série économique



- Pas 6mm (DIN 04-1)
- Diam. rouleau 4mm
- Matière :
Acier C45 UNI7845
- Ces pièces ne sont pas modifiables par nos soins
- **Les préalésages sont donnés à titre indicatif et peuvent varier en fonction des livraisons

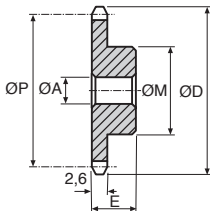

Accessoires

- Chaînes réf. SUA-6/M (tome 4 p.122)

REMISES

Qté	1+	6+	20+	40+
Rem.	Prix	-12%	-25%	Sur demande

Références	Z Dents	ØP	ØD	ØM	Préalésage non garanti		Poids (kg)	Prix Uni. 1 à 5
					ØA**	E		
PCS6-10	10	19,42	21,70	13	6	10	0,01	2,02 €
PCS6-11	11	21,30	23,60	14	6	10	0,01	2,15 €
PCS6-12	12	23,18	25,40	16	6	10	0,02	3,38 €
PCS6-13	13	25,05	27,30	18	8	10	0,02	3,39 €
PCS6-14	14	26,96	29,20	20	8	10	0,03	3,31 €
PCS6-15	15	28,86	31,00	20	8	10	0,03	3,40 €
PCS6-16	16	30,76	33,00	20	8	13	0,03	3,41 €
PCS6-17	17	32,65	35,00	20	8	13	0,04	3,36 €
PCS6-18	18	34,55	36,90	20	8	13	0,04	3,36 €
PCS6-19	19	36,44	38,80	20	8	13	0,04	3,32 €
PCS6-20	20	38,34	40,70	20	8	13	0,04	3,31 €
PCS6-21	21	40,25	42,60	25	8	13	0,06	3,64 €
PCS6-22	22	42,16	44,50	25	8	13	0,06	4,04 €
PCS6-23	23	44,06	46,40	25	8	13	0,06	4,22 €
PCS6-24	24	45,96	48,30	25	8	13	0,07	4,33 €
PCS6-25	25	47,87	50,20	25	8	13	0,07	4,73 €
PCS6-27	27	51,67	54,00	30	8	15	0,10	5,02 €
PCS6-30	30	57,42	59,80	30	8	15	0,11	6,67 €
PCS6-33	33	63,11	65,50	30	8	15	0,12	7,17 €
PCS6-35	35	66,93	69,30	30	8	15	0,13	7,54 €
PCS6-36	36	68,84	71,20	30	8	15	0,13	8,16 €
PCS6-38	38	72,66	75,00	30	8	15	0,14	8,34 €
PCS6-40	40	76,47	78,90	30	8	15	0,15	9,08 €
PCS6-45	45	86,01	88,50	40	10	16	0,46	11,41 €
PCS6-48	48	91,74	94,20	62	12	18	0,48	11,79 €
PCS6-50	50	95,55	98,00	50	12	20	0,49	11,82 €
PCS6-57	57	108,93	111,40	50	12	20	0,53	13,13 €
PCS6-76	76	145,19	147,60	60	12	20	1,58	25,91 €

Dimensions en mm

DIN 05B-1 8mm



Acier C45

Série économique

- Pas 8mm (DIN 05B-1)
- Diam. rouleau 5mm
- Matière :
Acier C45 UNI7845

- Ces pièces ne sont pas modifiables par nos soins

- **Les préalésages sont donnés à titre indicatif et peuvent varier en fonction des livraisons

Accessoires

- Chaînes réf. SBR-8/M, SBS-8/M (tome 4 p.122, p.124)

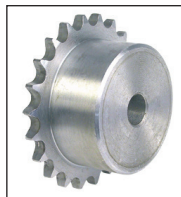
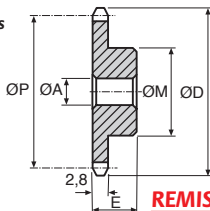

REMISES

Qté	1+	6+	20+	40+
Rem.	Prix	-12%	-25%	Sur demande

Références	Z Dents	ØP	ØD	ØM	Préalésage non garanti		E	Poids (kg)	Prix Uni. 1 à 5
					ØA**				
PCS8-8	8	20,90	24,0	13	6		12	0,01	1,93 €
PCS8-9	9	23,39	26,6	15	6		12	0,02	1,92 €
PCS8-10	10	25,89	29,2	17	8		12	0,02	2,03 €
PCS8-11	11	28,39	31,7	18	8		13	0,03	2,15 €
PCS8-12	12	30,91	34,2	20	8		13	0,04	3,09 €
PCS8-13	13	33,42	36,7	23	8		13	0,05	3,12 €
PCS8-14	14	35,95	39,2	25	8		13	0,05	3,27 €
PCS8-15	15	38,48	41,7	28	8		13	0,07	3,50 €
PCS8-16	16	41,01	44,3	30	8		14	0,08	3,49 €
PCS8-17	17	43,53	46,8	30	8		14	0,09	3,64 €
PCS8-18	18	46,07	49,3	30	8		14	0,09	4,20 €
PCS8-19	19	48,61	51,9	30	8		14	0,09	4,19 €
PCS8-20	20	51,14	54,4	30	8		14	0,10	4,19 €
PCS8-21	21	53,68	57,0	35	8		14	0,12	4,27 €
PCS8-23	23	58,75	62,0	35	8		14	0,13	4,46 €
PCS8-25	25	63,83	67,5	35	8		14	0,15	4,93 €
PCS8-27	27	68,91	72,2	40	10		16	0,20	5,17 €
PCS8-30	30	76,53	79,8	40	10		16	0,22	7,08 €
PCS8-33	33	84,16	87,5	40	10		16	0,24	7,61 €
PCS8-35	35	89,25	92,5	40	10		16	0,25	8,33 €
PCS8-36	36	91,79	95,0	40	10		16	0,26	8,70 €
PCS8-38	38	96,88	100,2	40	10		16	0,28	9,65 €
PCS8-39	39	99,42	102,7	40	10		16	0,29	9,51 €
PCS8-40	40	101,97	105,3	40	10		16	0,58	10,84 €
PCS8-45	45	114,69	118,0	60	12		20	0,67	14,23 €
PCS8-48	48	122,32	125,6	60	12		20	0,63	16,79 €
PCS8-50	50	127,41	130,7	60	12		20	1,00	16,54 €

Dimensions en mm



- Pas 1/4" (6,35mm)
- Diam. rouleau 3,3mm
- Matière :
Acier C45 UNI7845
- Ces pièces ne sont pas modifiables par nos soins
- **Les préalésages sont donnés à titre indicatif et peuvent varier en fonction des livraisons

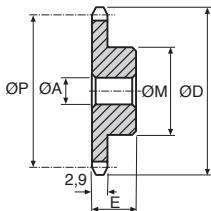

Accessoire

- Chaîne réf. SUA-250/M (tome 4 p.122)

Série économique

REMISES

Qté	1+	6+	20+	40+
Rem.	Prix	-12%	-25%	Sur demande

Références	Z Dents	ØP	ØD	ØM	Préalésage non garanti ØA**	E	Poids (kg)	Prix Uni. 1 à 5
PCS25-8	8	16,58	19,4	10	6	12	0,01	2,24 €
PCS25-9	9	18,56	21,4	11,5	6	12	0,01	2,25 €
PCS25-10	10	20,55	23,3	13	6	12	0,02	2,36 €
PCS25-11	11	22,54	25,3	15	8	13	0,02	3,06 €
PCS25-12	12	24,53	27,3	17	8	13	0,02	3,51 €
PCS25-13	13	26,53	29,3	17	8	13	0,03	3,50 €
PCS25-14	14	28,53	31,3	17	8	13	0,03	3,72 €
PCS25-15	15	30,53	33,3	20	8	13	0,04	3,96 €
PCS25-16	16	32,55	35,3	22	8	14	0,05	3,94 €
PCS25-17	17	34,55	37,3	22	8	14	0,05	4,00 €
PCS25-18	18	36,56	39,4	25	8	14	0,06	4,14 €
PCS25-19	19	38,58	41,4	25	8	14	0,06	4,24 €
PCS25-20	20	40,58	43,4	25	8	14	0,06	4,34 €
PCS25-21	21	42,60	45,4	30	8	14	0,08	4,68 €
PCS25-25	25	50,66	53,5	30	8	14	0,10	5,63 €
PCS25-28	28	56,71	59,5	30	8	16	0,12	7,13 €
PCS25-29	29	58,73	61,5	30	8	16	0,12	7,53 €
PCS25-30	30	60,75	63,6	30	8	16	0,13	7,60 €
PCS25-32	32	64,78	67,6	30	8	16	0,13	8,81 €
PCS25-33	33	66,80	69,6	30	8	16	0,14	9,20 €
PCS25-34	34	68,82	71,6	30	8	16	0,17	9,30 €
PCS25-35	35	70,84	73,6	30	8	16	0,17	9,74 €
PCS25-36	36	72,85	75,6	30	8	16	0,15	10,22 €
PCS25-37	37	74,87	77,7	30	8	16	0,18	11,98 €
PCS25-38	38	76,89	79,7	30	8	16	0,16	13,22 €
PCS25-39	39	78,91	81,7	30	8	16	0,19	14,43 €
PCS25-40	40	80,93	83,7	30	8	16	0,17	15,82 €

Dimensions en mm

Pignon à chaîne



DIN06B-1 3/8"



Acier C43

Série économique

- Pas 3/8" (9,525mm) (DIN 06B-1)
- Diam. rouleau 6,35mm
- Matière : acier C43
- Ces pièces ne sont pas modifiables par nos soins
- **Les préalésages sont donnés à titre indicatif et peuvent varier en fonction des livraisons

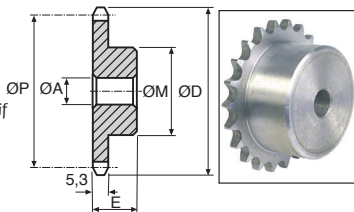

Options

- Pas américain (ASA) sur demande
- Réalisations sur mesure

Accessoires

- Chaîne réf. SBR-375 (tome 4 p.122)

REMISES

Qté	1+	6+	20+	40+
Rem.	Prix -12%	-25%	Sur demande	

Références	Z Dents	ØP	ØD	ØM	Préalésage non garanti		E	Stock*	Prix Uni. 1 à 5
					ØA**				
PCS37-8	8	24,89	28,0	15	8	22	✓	2,00 €	
PCS37-9	9	27,85	31,0	18	8	22	✓	2,16 €	
PCS37-10	10	30,82	34,0	20	8	22	✓	2,13 €	
PCS37-12	12	36,80	40,0	25	8	25	✓	3,21 €	
PCS37-13	13	39,80	43,0	28	10	25	✓	3,42 €	
PCS37-14	14	42,80	46,3	31	10	25	✓	3,84 €	
PCS37-15	15	45,81	49,3	34	10	25	✓	3,88 €	
PCS37-16	16	48,82	52,3	37	10	28	✓	4,46 €	
PCS37-17	17	51,83	55,3	40	10	28	✓	5,04 €	
PCS37-18	18	54,85	58,3	43	10	28	✓	5,19 €	
PCS37-20	20	60,89	64,3	46	10	28	✓	5,97 €	
PCS37-21	21	63,91	68,0	48	12	28	✓	6,05 €	
PCS37-22	22	66,93	71,0	50	12	28	✓	6,81 €	
PCS37-23	23	69,95	73,5	52	12	28	-	7,39 €	
PCS37-24	24	72,97	77,0	54	12	28	✓	7,86 €	
PCS37-25	25	76,00	80,0	57	12	28	✓	8,60 €	
PCS37-26	26	79,02	83,0	60	12	28	✓	8,73 €	
PCS37-27	27	82,04	86,0	60	12	28	✓	8,97 €	
PCS37-28	28	85,07	89,0	60	12	28	-	9,15 €	
PCS37-29	29	88,09	92,0	60	12	28	-	9,69 €	
PCS37-30	30	91,12	94,7	60	12	28	✓	10,14 €	
PCS37-32	32	97,17	101,3	65	14	30	✓	11,95 €	
PCS37-33	33	100,20	104,3	65	14	30	-	12,74 €	
PCS37-34	34	103,23	107,3	65	14	30	✓	12,72 €	
PCS37-35	35	106,26	110,4	65	14	30	-	13,58 €	
PCS37-36	36	109,29	113,4	70	14	30	-	14,15 €	
PCS37-38	38	115,34	119,5	70	14	30	-	14,72 €	
PCS37-40	40	121,40	125,5	70	14	30	✓	15,16 €	

*Dans la limite du disponible - Dimensions en mm

Inox 304

DIN 06B-1
3/8"



- Pas 3/8" (9,525mm) (DIN 06B-1)
- Diam. rouleau 6,35mm
- Matière :
Inox AISI 304
- Ces pièces ne sont pas modifiables par nos soins
- **Les préalésages sont donnés à titre indicatif et peuvent varier en fonction des livraisons

Options

- Pas américain (ASA) sur demande
- Réalisations sur mesure

Accessoire

- Chaîne réf. SBS-375 (tome 4 p.124)

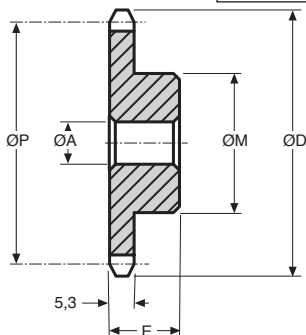

REMISES

Qté	1+	4+	10+
Rem. Prix	-12%	Sur demande	

Références	Z Dents	ØP	ØD	ØM	Préalésage non garanti ØA**	E	Stock*	Prix Uni. 1 à 3
PCS37-12/SS	12	36,80	40,0	25	8	25	✓	16,24 €
PCS37-13/SS	13	39,80	43,0	28	10	25	✓	16,94 €
PCS37-15/SS	15	45,81	49,3	34	10	25	✓	18,58 €
PCS37-16/SS	16	48,82	52,3	37	10	28	✓	22,69 €
PCS37-17/SS	17	51,83	55,3	40	10	28	✓	24,22 €
PCS37-18/SS	18	54,85	58,3	43	10	28	✓	25,23 €
PCS37-19/SS	19	57,87	61,3	46	10	28	-	25,68 €
PCS37-20/SS	20	60,89	64,3	46	10	28	✓	27,23 €
PCS37-21/SS	21	63,91	68,0	48	12	28	-	25,16 €
PCS37-23/SS	23	69,95	73,5	52	12	28	-	30,54 €
PCS37-25/SS	25	76,00	80,0	57	12	28	✓	33,59 €
PCS37-30/SS	30	91,12	94,7	60	12	30	✓	41,49 €

*Dans la limite du disponible - Dimensions en mm

Pignon à chaîne



DIN 08B-1 1/2"

Acier C43

Série économique

- Pas 1/2" (12,7mm) (DIN 08B-1)
- Diam. rouleur 8,51mm
- Matière : acier C43
- Ces pièces ne sont pas modifiables par nos soins
- **Les préalésages sont donnés à titre indicatif et peuvent varier en fonction des livraisons

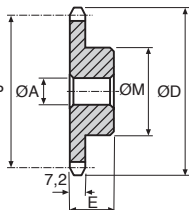

Options

- Pas américain (ASA) sur demande
- Réalisations sur mesure

Accessoire

- Chaîne réf. SBR-500 (tome 4 p.122)

REMISES

Qté	1+	6+	20+	40+
Rem.	Prix -12%	-25%	Sur demande	

Références	Z Dents	ØP	ØD	ØM	Préalésage non garanti		E	Stock*	Prix Uni. 1 à 5
					ØA**				
PCS50-8	8	33,18	37,2	20	10	25	✓	2,31 €	
PCS50-9	9	37,13	41,0	24	10	25	✓	3,47 €	
PCS50-10	10	41,10	45,2	26	10	25	✓	4,02 €	
PCS50-12	12	49,07	53,0	33	10	28	✓	5,35 €	
PCS50-15	15	61,09	65,5	45	10	28	✓	6,76 €	
PCS50-16	16	65,10	69,5	50	12	28	✓	7,48 €	
PCS50-18	18	73,14	77,8	56	12	28	✓	8,11 €	
PCS50-20	20	81,19	85,8	64	12	28	✓	10,48 €	
PCS50-21	21	85,22	89,7	68	14	28	✓	11,11 €	
PCS50-22	22	89,24	93,8	70	14	28	✓	11,48 €	
PCS50-23	23	93,27	98,2	70	14	28	-	11,90 €	
PCS50-24	24	97,29	101,8	70	14	28	✓	12,67 €	
PCS50-25	25	101,33	105,8	70	14	28	✓	12,92 €	
PCS50-26	26	105,36	110,0	70	16	30	✓	13,74 €	
PCS50-27	27	109,40	114,0	70	16	30	-	13,94 €	
PCS50-28	28	113,42	118,0	70	16	30	✓	14,28 €	
PCS50-29	29	117,46	122,0	80	16	30	-	16,18 €	
PCS50-30	30	121,50	126,1	80	16	30	✓	18,00 €	
PCS50-31	31	125,54	130,2	90	16	30	-	18,93 €	
PCS50-32	32	129,56	134,3	90	16	30	-	19,18 €	
PCS50-33	33	133,60	138,4	90	16	30	-	19,39 €	
PCS50-34	34	137,64	142,6	90	16	30	-	21,75 €	
PCS50-35	35	141,68	146,7	90	16	30	-	22,36 €	
PCS50-36	36	145,72	151,0	90	20	35	✓	24,79 €	
PCS50-37	37	149,76	154,6	90	20	35	-	25,47 €	
PCS50-38	38	153,80	158,6	90	20	35	-	25,63 €	
PCS50-39	39	157,83	162,7	90	20	35	-	26,91 €	
PCS50-40	40	161,87	166,8	90	20	35	✓	27,43 €	

*Dans la limite du disponible - Dimensions en mm

Inox 304

DIN 08B-1 1/2"

- Pas 1/2" (12,7mm) (DIN 08B-1)
- Diam. rouleau 8,51mm
- Matière :
Inox AISI 304

- **Ces pièces ne sont pas modifiables par nos soins**

- *Les préalésages sont donnés à titre indicatif et peuvent varier en fonction des livraisons



Options

- Pas américain (ASA) sur demande
- Réalisations sur mesure

Accessoire

- Chaîne réf. SBS-500 (tome 4 p.124)

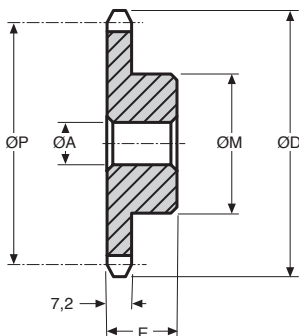
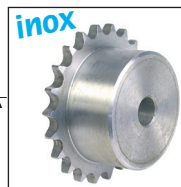

REMISES

Qté	1+	4+	10+
Rem. Prix	-12%	Sur demande	

Références	Z Dents	ØP	ØD	ØM	Préalésage non garanti		E	Stock*	Prix Uni. 1 à 3
					ØA*				
PCS50-12/SS	12	49,07	53,0	33	10	28	✓	20,44 €	
PCS50-13/SS	13	53,06	57,4	37	10	28	✓	22,76 €	
PCS50-15/SS	15	61,09	65,5	45	10	28	✓	25,92 €	
PCS50-16/SS	16	65,10	69,5	50	12	28	-	27,20 €	
PCS50-17/SS	17	69,11	73,6	52	12	28	✓	29,60 €	
PCS50-18/SS	18	73,14	77,8	56	12	28	-	34,05 €	
PCS50-19/SS	19	77,16	81,7	60	12	28	✓	36,12 €	
PCS50-20/SS	20	81,19	85,8	64	12	28	✓	39,96 €	
PCS50-21/SS	21	85,22	89,7	68	14	28	-	44,07 €	
PCS50-23/SS	23	93,27	98,2	70	14	28	-	49,55 €	
PCS50-25/SS	25	101,33	105,8	70	14	28	✓	59,14 €	
PCS50-30/SS	30	121,50	126,1	80	16	30	-	88,13 €	

*Dans la limite du disponible - Dimensions en mm

DIN 10B-1 5/8"

Acier C43

- Pas 5/8" (15,875mm) (DIN 10B-1)
- Diam. rouleau 10,16mm
- Matière : acier C43
- **Ces pièces ne sont pas modifiables par nos soins**
- **Les préalésages sont donnés à titre indicatif et peuvent varier en fonction des livraisons

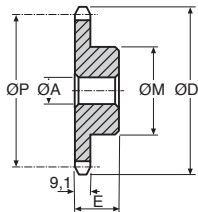

Options

- Pas américain (ASA) sur demande
- Réalisations sur mesure

Accessoire

- Chaîne réf. SBR-625 (tome 4 p.122)

Série économique

REMISES

Qté	1+	6+	20+	40+
Rem.	Prix -12%	-25%	Sur demande	

Références	Z Dents	ØP	ØD	ØM	Préalésage non garanti		E	Stock*	Prix Uni. 1 à 5
					ØA**				
PCS62-8	8	41,48	47,0	25	10	25	✓	3,88 €	
PCS62-9	9	46,42	52,6	30	10	25	-	4,40 €	
PCS62-10	10	51,37	57,5	35	10	25	✓	5,25 €	
PCS62-13	13	66,32	73,0	47	12	30	✓	8,34 €	
PCS62-15	15	76,36	83,0	57	12	30	✓	9,65 €	
PCS62-16	16	81,37	88,0	60	14	30	✓	10,93 €	
PCS62-17	17	86,39	93,0	60	14	30	✓	11,60 €	
PCS62-18	18	91,42	98,3	70	14	30	✓	14,23 €	
PCS62-20	20	101,49	108,4	75	14	30	✓	14,47 €	
PCS62-21	21	106,52	113,4	75	16	30	✓	15,01 €	
PCS62-22	22	111,55	118,0	80	16	30	-	16,07 €	
PCS62-23	23	116,58	123,4	80	16	30	-	16,77 €	
PCS62-24	24	121,62	128,3	80	16	30	-	17,43 €	
PCS62-25	25	126,66	134,0	80	16	30	-	18,70 €	
PCS62-26	26	131,70	139,0	85	20	35	-	22,23 €	
PCS62-27	27	136,75	144,0	85	20	35	-	24,00 €	
PCS62-28	28	141,78	148,7	90	20	35	-	24,98 €	
PCS62-29	29	146,83	153,8	90	20	35	-	26,39 €	
PCS62-30	30	151,87	158,8	90	20	35	✓	27,52 €	
PCS62-31	31	156,92	163,9	95	20	35	-	29,40 €	
PCS62-32	32	161,95	168,9	95	20	35	-	30,84 €	
PCS62-33	33	167,00	174,5	95	20	35	-	31,85 €	
PCS62-34	34	172,05	179,0	95	20	35	-	30,98 €	
PCS62-35	35	177,10	184,1	95	20	35	-	31,58 €	
PCS62-38	38	192,24	199,2	100	20	35	-	38,54 €	
PCS62-39	39	197,29	204,2	100	20	35	-	40,35 €	
PCS62-40	40	202,34	209,3	100	20	35	✓	41,45 €	

*Dans la limite du disponible - Dimensions en mm

Inox 304

DIN 10B-1 5/8"

- Pas 5/8" (15,875mm) (DIN 10B-1)
- Diam. rouleau 10,16mm
- Matière :
Inox AISI 304
- **Ces pièces ne sont pas modifiables par nos soins**
- Les pré-alésages sont donnés à titre indicatif et peuvent varier en fonction des livraisons



Options

- Pas américain (ASA) sur demande
- Réalisations sur mesure

Accessoire

- Chaîne réf. SBS-625 (tome 4 p.124)

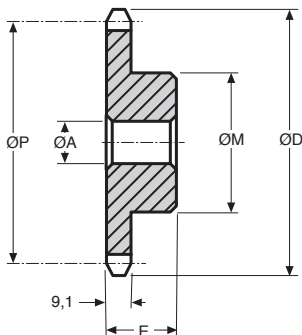

REMISES

Qté	1+	4+	10+
Rem. Prix	-12% Sur demande		

Références	Z Dents	ØP	ØD	ØM	Préalésage non garanti ØA*	E	Prix Uni. 1 à 3
PCS62-12/SS	12	61,34	68,0	42	12	30	29,14 €
PCS62-13/SS	13	66,32	73,0	47	12	30	31,60 €
PCS62-15/SS	15	76,36	83,0	57	12	30	38,90 €
PCS62-16/SS	16	81,37	88,0	60	14	30	43,62 €
PCS62-17/SS	17	86,39	93,0	60	14	30	46,52 €
PCS62-18/SS	18	91,42	98,3	70	14	30	58,24 €
PCS62-19/SS	19	96,45	103,3	70	14	30	59,07 €
PCS62-20/SS	20	101,49	108,4	75	14	30	68,26 €
PCS62-21/SS	21	106,52	113,4	75	16	30	65,79 €
PCS62-23/SS	23	116,58	123,4	80	16	30	82,39 €
PCS62-25/SS	25	126,66	134,0	80	16	30	98,02 €
PCS62-30/SS	30	151,87	158,8	90	20	35	117,52 €

Dimensions en mm

Pignon à chaîne alésé rainuré



DIN06B-1 Acier traité C45, denture trempée

3/8"



- Pas 9,525mm (DIN 06B-1)
- Diam. rouleau 6,35mm
- Matière :
Acier C45 UNI7845
Denture trempée 45-53HRC

Info

- Rainure de clavette selon DIN6885 dans l'axe d'une dent
- 2 trous taraudés à 90°

Alésage et rainure de clavette

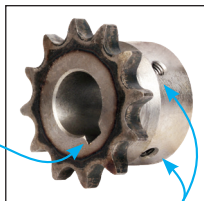

Accessoire

- Chaîne SBR-375/M (tome 4 p.122)

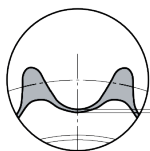

0.6+1mm
prof.

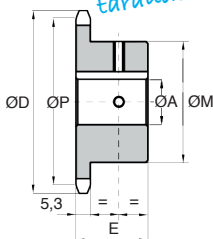
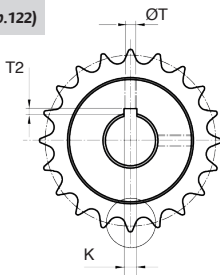

2 trous taraudés

REMISES

Qté	1+	6+	20+	40+
Rem.	Prix	-12%	-25%	Sur demande

Références	Z	Dents	ØP	ØD	ØM	E	K	(H9)	T2	ØT	Stock*	Prix Uni.
PCS37-12H-12K	12	36,80	40,45	30	25	12	4	1,80	M4	✓	7,33 €	
14						5	2,30	M4	-	7,33 €		
15						5	2,30	M4	✓	7,33 €		
16						5	2,30	M4	✓	7,33 €		
PCS37-13H-12K	13	39,80	43,50	28	25	12	4	1,80	M4	✓	7,83 €	
14						5	2,30	M4	-	7,83 €		
15						5	2,30	M4	✓	7,83 €		
16						5	2,30	M4	-	7,83 €		
PCS37-13H-18K	13	39,80	43,50	28	25	18	6	2,80	M5	-	7,83 €	
PCS37-14H-12K						14	42,80	46,50	31	25	12	4
14	5	2,30	M4	-	8,43 €							
15	5	2,30	M4	✓	8,43 €							
16	5	2,30	M4	✓	8,43 €							
PCS37-14H-18K	14	42,80	46,50	31	25	18	6	2,80	M5	-	8,43 €	

*Dans la limite du disponible - Dimensions en mm

REMISES

Qté	1+	6+	20+	40+
Rem. Prix	-12%	-25%	Sur demande	

Références	Z					K			Stock*	Prix Uni. 1 à 5						
	Dents	ØP	ØD	ØM	E	ØA	(H9)	T2	ØT							
PCS37-15H-14K	15	45,81	49,50	34	25	14	5	2,30	M4	✓	8,63 €					
PCS37-15H-15K						15	5	2,30	M4	-	8,63 €					
PCS37-15H-16K						16	5	2,30	M4	-	8,63 €					
PCS37-15H-18K						18	6	2,80	M4	✓	8,63 €					
PCS37-15H-19K						19	6	2,80	M5	-	8,63 €					
PCS37-15H-20K						20	6	2,80	M5	✓	8,63 €					
PCS37-15H-22K						22	6	2,80	M5	-	8,63 €					
PCS37-15H-24K						24	8	3,30	M6	-	8,63 €					
PCS37-16H-14K						16	48,82	52,30	37	28	14	5	2,30	M4	✓	8,57 €
PCS37-16H-15K											15	5	2,30	M4	✓	8,15 €
PCS37-16H-16K	16	5	2,30	M4	-						8,57 €					
PCS37-16H-18K	18	6	2,80	M5	-						8,57 €					
PCS37-16H-19K	19	6	2,80	M5	-						8,57 €					
PCS37-16H-20K	20	6	2,80	M5	✓						8,57 €					
PCS37-16H-22K	22	6	2,80	M5	-						8,57 €					
PCS37-16H-24K	24	8	3,30	M6	-						8,57 €					
PCS37-17H-14K	17	51,83	55,50	40	28						14	5	2,30	M4	-	9,10 €
PCS37-17H-15K											15	5	2,30	M4	✓	9,10 €
PCS37-17H-16K						16	5	2,30	M4	-	9,10 €					
PCS37-17H-18K						18	6	2,80	M5	✓	9,10 €					
PCS37-17H-19K						19	6	2,80	M5	-	9,10 €					
PCS37-17H-20K						20	6	2,80	M5	✓	9,10 €					
PCS37-17H-22K						22	6	2,80	M5	-	9,10 €					
PCS37-17H-24K						24	8	3,30	M6	✓	9,10 €					
PCS37-18H-14K						18	54,85	58,30	43	28	14	5	2,30	M4	-	9,18 €
PCS37-18H-15K											15	5	2,30	M4	✓	9,18 €
PCS37-18H-16K	16	5	2,30	M4	-						9,18 €					
PCS37-18H-18K	18	6	2,80	M5	-						9,18 €					
PCS37-18H-19K	19	6	2,80	M5	-						9,18 €					
PCS37-18H-20K	20	6	2,80	M5	✓						9,18 €					
PCS37-18H-22K	22	6	2,80	M5	-						9,18 €					
PCS37-18H-24K	24	8	3,30	M6	-						9,18 €					
PCS37-19H-15K	19	57,87	61,60	45	28						15	5	2,30	M4	✓	9,60 €
PCS37-19H-16K											16	5	2,30	M4	-	9,60 €
PCS37-19H-18K						18	6	2,80	M5	-	9,60 €					
PCS37-19H-19K						19	6	2,80	M5	-	9,60 €					
PCS37-19H-20K						20	6	2,80	M5	✓	9,60 €					
PCS37-19H-22K						22	6	2,80	M5	-	9,60 €					
PCS37-19H-24K						24	8	3,30	M6	-	9,60 €					
PCS37-19H-25K						25	8	3,30	M6	✓	9,60 €					
PCS37-20H-15K						20	60,89	64,30	46	28	15	5	2,30	M4	-	10,19 €
PCS37-20H-16K											16	5	2,30	M4	-	10,19 €
PCS37-20H-18K	18	6	2,80	M5	-						10,19 €					
PCS37-20H-19K	19	6	2,80	M5	-						10,19 €					
PCS37-20H-20K	20	6	2,80	M5	✓						10,19 €					
PCS37-20H-22K	22	6	2,80	M5	-						10,19 €					
PCS37-20H-24K	24	8	3,30	M6	-						10,19 €					
PCS37-20H-25K	25	8	3,30	M6	✓						10,19 €					

*Dans la limite du disponible - Dimensions en mm

Pignon à chaîne alésé rainuré



DIN06B-1 Acier traité C45, denture trempée

3/8"



- Pas 9,525mm (DIN 06B-1)
- Diam. rouleau 6,35mm
- Matière :
Acier C45 UNI7845
Denture trempée 45-53HRC

Info

- Rainure de clavette selon DIN6885 dans l'axe d'une dent
- 2 trous taraudés à 90°

Accessoire

- Chaîne SBR-375/M (tome 4 p.122)

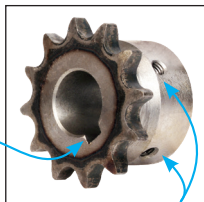

Alésage et rainure de clavette

2 trous taraudés

REMISES

Qté	1+	6+	20+	40+
Rem.	Prix	-12%	-25%	Sur demande

Références	Z	Dents	ØP	ØD	ØM	E	ØA	K (H9)	T2	ØT	Stock*	Prix Uni. 1 à 5
PCS37-21H-15K	21	63,91	67,60	48	28	15	5	2,30	M4	-	10,53 €	
PCS37-21H-16K						16	5	2,30	M4	-	10,53 €	
PCS37-21H-18K						18	6	2,80	M5	-	10,53 €	
PCS37-21H-19K						19	6	2,80	M5	-	10,53 €	
PCS37-21H-20K						20	6	2,80	M5	-	10,53 €	
PCS37-21H-22K						22	6	2,80	M5	-	10,53 €	
PCS37-21H-24K						24	8	3,30	M6	-	10,53 €	
PCS37-21H-25K						25	8	3,30	M6	✓	10,53 €	
PCS37-23H-15K	23	69,95	73,70	52	28	15	5	2,30	M4	✓	12,06 €	
PCS37-23H-16K						16	5	2,30	M4	-	12,06 €	
PCS37-23H-18K						18	6	2,80	M5	-	12,06 €	
PCS37-23H-19K						19	6	2,80	M5	-	12,06 €	
PCS37-23H-20K						20	6	2,80	M5	✓	12,06 €	
PCS37-23H-22K						22	6	2,80	M5	-	12,06 €	
PCS37-23H-24K						24	8	3,30	M6	-	12,06 €	
PCS37-23H-25K						25	8	3,30	M6	✓	12,06 €	

*Dans la limite du disponible - Dimensions en mm

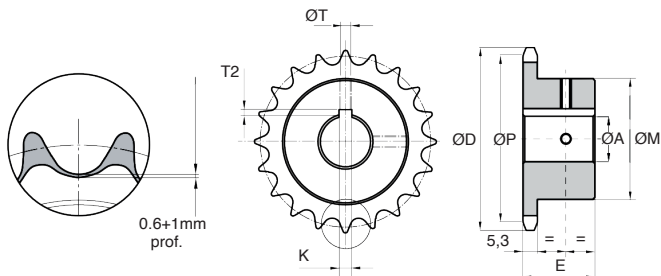

REMISES

Qté	1+	6+	20+	40+
Rem.	Prix	-12%	-25%	Sur demande

Références	Z		ØP	ØD	ØM	E	K		T2	ØT	Stock*	Prix Uni. 1 à 5				
	Dents						(H9)									
PCS37-24H-18K	24	72,97	76,70	54	28	18	6	2,80	M5	-	12,88 €					
PCS37-24H-19K						19	6	2,80	M5	-	12,88 €					
PCS37-24H-20K						20	6	2,80	M5	✓	12,88 €					
PCS37-24H-22K						22	6	2,80	M5	-	12,88 €					
PCS37-24H-24K						24	8	3,30	M6	-	12,88 €					
PCS37-24H-25K						25	8	3,30	M6	-	12,88 €					
PCS37-24H-28K						28	8	3,30	M6	-	12,88 €					
PCS37-24H-30K						30	8	3,30	M6	-	12,88 €					
PCS37-25H-18K						25	76,00	79,70	57	28	18	6	2,80	M5	-	13,82 €
PCS37-25H-19K											19	6	2,80	M5	-	15,15 €
PCS37-25H-20K	20	6	2,80	M5	-						13,82 €					
PCS37-25H-22K	22	6	2,80	M5	-						13,82 €					
PCS37-25H-24K	24	8	3,30	M6	-						13,82 €					
PCS37-25H-25K	25	8	3,30	M6	-						13,82 €					
PCS37-25H-28K	28	8	3,30	M6	-						13,82 €					
PCS37-25H-30K	30	8	3,30	M6	-						13,82 €					
PCS37-27H-20K	27	82,05	85,70	60	28						20	6	2,80	M5	✓	16,46 €
PCS37-27H-22K											22	6	2,80	M5	-	16,46 €
PCS37-27H-24K						24	8	3,30	M6	-	16,46 €					
PCS37-27H-25K						25	8	3,30	M6	-	16,46 €					
PCS37-27H-28K						28	8	3,30	M6	-	16,46 €					
PCS37-27H-30K						30	8	3,30	M6	-	16,46 €					
PCS37-30H-20K	30	91,12	94,80	60	30	20	6	2,80	M5	-	19,18 €					
PCS37-30H-22K						22	6	2,80	M5	-	19,18 €					
PCS37-30H-24K						24	8	3,30	M6	-	19,18 €					
PCS37-30H-25K						25	8	3,30	M6	✓	19,18 €					
PCS37-30H-28K						28	8	3,30	M6	-	19,18 €					
PCS37-30H-30K						30	8	3,30	M6	-	19,18 €					

*Dans la limite du disponible - Dimensions en mm

Pignon à chaîne alésé rainuré



DIN08B-1 Acier traité C45, denture trempée

1/2"



- Pas 12,7mm (DIN 08B-1)
- Diam. rouleau 8,51mm
- Matière :
Acier C45 UNI7845
Denture trempée 45-53HRC

Info

- Rainure de clavette selon DIN6885 dans l'axe d'une dent
- 2 trous taraudés à 90°

Accessoire

- Chaîne SBR-500/M (tome 4 p.122)

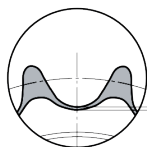

0.6+1mm
prof.

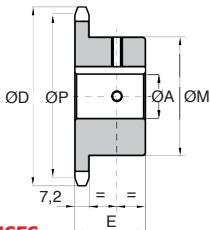
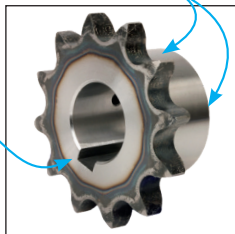
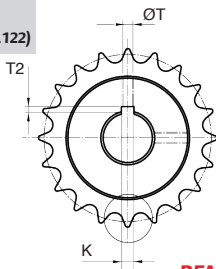

REMISES

Qté	1+	6+	20+	40+
Rem. Prix	-12%	-25%	Sur demande	

Références	Z Dents	ØP	ØD	ØM	E	ØA	K (H9)	T2	ØT	Stock*	Prix Uni. 1 à 5
PCS50-12H-12K	12	49,07	53,90	33	28	12	4	1,80	M4	✓	9,81 €
PCS50-12H-14K						14	5	2,30	M4	✓	9,81 €
PCS50-12H-15K						15	5	2,30	M4	-	9,81 €
PCS50-12H-16K						16	5	2,30	M4	✓	9,81 €
PCS50-12H-18K						18	6	2,80	M5	✓	9,81 €
PCS50-12H-19K	19	6	2,80	M5	✓	9,81 €					
PCS50-12H-20K	20	6	2,80	M5	✓	9,81 €					
PCS50-13H-12K	13	53,06	57,90	37	28	12	4	1,80	M4	✓	10,04 €
PCS50-13H-14K						14	5	2,30	M4	✓	10,04 €
PCS50-13H-15K						15	5	2,30	M4	-	10,04 €
PCS50-13H-16K						16	5	2,30	M4	-	10,04 €
PCS50-13H-18K						18	6	2,80	M5	-	10,04 €
PCS50-13H-19K						19	6	2,80	M5	✓	10,04 €
PCS50-13H-20K						20	6	2,80	M5	✓	10,04 €
PCS50-13H-22K						22	6	2,80	M5	-	10,04 €
PCS50-13H-24K	24	8	3,30	M6	✓	10,04 €					

*Dans la limite du disponible - Dimensions en mm

Références	Z					K			Stock*	Prix Uni. 1 à 5	
	Dents	ØP	ØD	ØM	E	ØA	(H9)	T2			ØT
PCS50-14H-14K	14	57,07	61,60	41	28	14	5	2,30	M4	-	10,84 €
PCS50-14H-15K						15	5	2,30	M4	-	10,84 €
PCS50-14H-16K						16	5	2,30	M4	-	10,84 €
PCS50-14H-18K						18	6	2,80	M5	✓	10,84 €
PCS50-14H-19K						19	6	2,80	M5	-	10,84 €
PCS50-14H-20K						20	6	2,80	M5	✓	10,84 €
PCS50-14H-22K						22	6	2,80	M5	-	10,84 €
PCS50-14H-24K						24	8	3,30	M6	-	10,84 €
PCS50-14H-25K						25	8	3,30	M6	✓	10,84 €
PCS50-15H-14K						15	61,09	65,90	45	28	14
PCS50-15H-15K	15	5	2,30	M4	-						11,44 €
PCS50-15H-16K	16	5	2,30	M4	-						11,44 €
PCS50-15H-18K	18	6	2,80	M4	-						11,44 €
PCS50-15H-19K	19	6	2,80	M5	✓						11,44 €
PCS50-15H-20K	20	6	2,80	M5	✓						11,44 €
PCS50-15H-22K	22	6	2,80	M5	-						11,44 €
PCS50-15H-24K	24	8	3,30	M6	-						11,44 €
PCS50-15H-25K	25	8	3,30	M6	✓						11,44 €
PCS50-15H-28K	28	8	3,30	M6	✓						11,44 €
PCS50-15H-30K	30	8	3,30	M6	-	11,44 €					
PCS50-16H-15K	16	65,10	69,50	50	28	15	5	2,30	M4	-	12,82 €
PCS50-16H-16K						16	5	2,30	M4	-	12,82 €
PCS50-16H-18K						18	6	2,80	M4	-	12,82 €
PCS50-16H-19K						19	6	2,80	M5	-	12,82 €
PCS50-16H-20K						20	6	2,80	M5	✓	12,82 €
PCS50-16H-22K						22	6	2,80	M5	-	12,82 €
PCS50-16H-24K						24	8	3,30	M6	-	12,82 €
PCS50-16H-25K						25	8	3,30	M6	✓	12,82 €
PCS50-16H-28K						28	8	3,30	M6	✓	12,82 €
PCS50-16H-30K						30	8	3,30	M6	-	12,82 €
PCS50-17H-15K	17	69,11	74,00	52	28	15	5	2,30	M4	-	13,23 €
PCS50-17H-16K						16	5	2,30	M4	-	13,23 €
PCS50-17H-18K						18	6	2,80	M4	-	13,23 €
PCS50-17H-19K						19	6	2,80	M5	-	13,23 €
PCS50-17H-20K						20	6	2,80	M5	✓	13,23 €
PCS50-17H-22K						22	6	2,80	M5	-	13,23 €
PCS50-17H-24K						24	8	3,30	M6	-	13,23 €
PCS50-17H-25K						25	8	3,30	M6	-	13,23 €
PCS50-17H-28K						28	8	3,30	M6	-	13,23 €
PCS50-17H-30K						30	8	3,30	M6	✓	13,23 €
PCS50-18H-16K	18	73,14	77,80	56	28	16	5	2,30	M4	-	13,80 €
PCS50-18H-18K						18	6	2,80	M4	-	13,80 €
PCS50-18H-19K						19	6	2,80	M5	-	13,80 €
PCS50-18H-20K						20	6	2,80	M5	✓	13,80 €
PCS50-18H-22K						22	6	2,80	M5	-	13,80 €
PCS50-18H-24K						24	8	3,30	M6	✓	13,80 €
PCS50-18H-25K						25	8	3,30	M6	-	13,80 €
PCS50-18H-28K						28	8	3,30	M6	-	13,80 €
PCS50-18H-30K						30	8	3,30	M6	✓	13,80 €
PCS50-18H-32K						32	10	3,30	M8	-	13,80 €
PCS50-18H-35K	35	10	3,30	M8	-	13,80 €					

*Dans la limite du disponible - Dimensions en mm

Pignon à chaîne alésé rainuré



DIN08B-1 Acier traité C45, denture trempée

1/2"



- Pas 12,7mm (DIN 08B-1)
- Diam. rouleau 8,51mm
- Matière :
Acier C45 UNI7845
Denture trempée 45-53HRC

Info

- Rainure de clavette selon DIN6885 dans l'axe d'une dent
- 2 trous taraudés à 90°

Accessoire

- Chaîne SBR-500/M (tome 4 p.122)

2 trous taraudés

Alésage et rainure de clavette

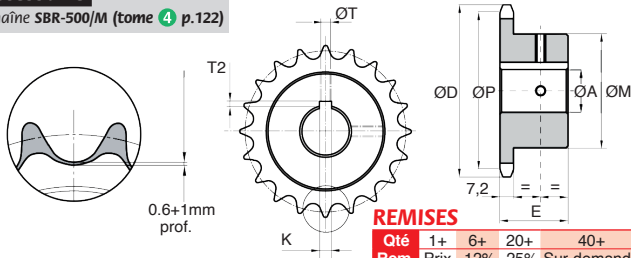
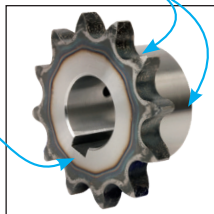

REMISES

Qté	1+	6+	20+	40+
Rem. Prix	-12%	-25%	Sur demande	

Références	Z	Dents	ØP	ØD	ØM	E	ØA	K (H9)	T2	ØT	Stock*	Prix Uni. 1 à 5
PCS50-19H-19K	19	77,16	82,00	60	28	19	6	2,80	M5	-	15,28 €	
PCS50-19H-20K						20	6	2,80	M5	✓	15,28 €	
PCS50-19H-22K						22	8	3,30	M6	-	15,28 €	
PCS50-19H-24K						24	8	3,30	M6	-	15,28 €	
PCS50-19H-25K						25	8	3,30	M6	✓	15,28 €	
PCS50-19H-28K						28	8	3,30	M6	-	15,28 €	
PCS50-19H-30K						30	10	3,30	M8	-	15,28 €	
PCS50-19H-32K						32	10	3,30	M8	-	15,28 €	
PCS50-19H-35K						35	10	3,30	M8	-	15,28 €	
PCS50-20H-19K						20	81,19	85,80	64	28	19	6
PCS50-20H-20K	20	6	2,80	M5	✓						15,97 €	
PCS50-20H-22K	22	6	2,80	M5	-						15,97 €	
PCS50-20H-24K	24	8	3,30	M6	-						15,97 €	
PCS50-20H-25K	25	8	3,30	M6	-						15,97 €	
PCS50-20H-28K	28	8	3,30	M6	-						15,97 €	
PCS50-20H-30K	30	8	3,30	M6	✓						15,97 €	
PCS50-20H-32K	32	10	3,30	M8	-						15,97 €	
PCS50-20H-35K	35	10	3,30	M8	-						15,97 €	

*Dans la limite du disponible - Dimensions en mm

Références	Z					K				Stock*	Prix Uni. 1 à 5
	Dents	ØP	ØD	ØM	E	ØA	(H9)	T2	ØT		
PCS50-21H-19K	21	85,22	90,10	68	28	19	6	2,80	M5	-	16,73 €
PCS50-21H-20K						20	6	2,80	M5	✓	16,73 €
PCS50-21H-22K						22	6	2,80	M5	-	16,73 €
PCS50-21H-24K						24	8	3,30	M6	-	16,73 €
PCS50-21H-25K						25	8	3,30	M6	-	16,73 €
PCS50-21H-28K						28	8	3,30	M6	-	16,73 €
PCS50-21H-30K						30	8	3,30	M6	-	16,73 €
PCS50-21H-32K						32	10	3,30	M8	-	16,73 €
PCS50-21H-35K						35	10	3,30	M8	-	16,73 €
PCS50-23H-20K						23	93,27	98,10	70	28	20
PCS50-23H-22K	22	6	2,80	M5	-						18,00 €
PCS50-23H-24K	24	8	3,30	M6	-						18,00 €
PCS50-23H-25K	25	8	3,30	M6	-						18,00 €
PCS50-23H-28K	28	8	3,30	M6	-						18,00 €
PCS50-23H-30K	30	8	3,30	M6	-						18,00 €
PCS50-23H-32K	32	10	3,30	M8	-						18,00 €
PCS50-23H-35K	35	10	3,30	M8	-						18,00 €
PCS50-23H-38K	38	10	3,30	M8	-						18,00 €
PCS50-24H-20K	24	97,29	102,70	70	28						20
PCS50-24H-22K						22	6	2,80	M5	-	19,19 €
PCS50-24H-24K						24	8	3,30	M6	✓	19,19 €
PCS50-24H-25K						25	8	3,30	M6	✓	19,19 €
PCS50-24H-28K						28	8	3,30	M6	-	19,19 €
PCS50-24H-30K						30	8	3,30	M6	-	19,19 €
PCS50-24H-32K						32	10	3,30	M8	-	19,19 €
PCS50-24H-35K						35	10	3,30	M8	-	19,19 €
PCS50-24H-38K						38	10	3,30	M8	-	19,19 €
PCS50-25H-20K						25	101,33	105,80	70	28	20
PCS50-25H-22K	22	6	2,80	M5	-						19,84 €
PCS50-25H-24K	24	8	3,30	M6	-						19,84 €
PCS50-25H-25K	25	8	3,30	M6	-						19,84 €
PCS50-25H-28K	28	8	3,30	M6	-						19,84 €
PCS50-25H-30K	30	8	3,30	M6	-						19,84 €
PCS50-25H-32K	32	10	3,30	M8	-						19,84 €
PCS50-25H-35K	35	10	3,30	M8	-						19,84 €
PCS50-25H-38K	38	10	3,30	M8	-						19,84 €
PCS50-27H-22K	27	109,40	114,00	70	30						22
PCS50-27H-25K						25	8	3,30	M6	✓	23,41 €
PCS50-27H-28K						28	8	3,30	M6	-	23,41 €
PCS50-27H-30K						30	8	3,30	M6	✓	23,41 €
PCS50-27H-32K						32	10	3,30	M8	-	23,41 €
PCS50-27H-35K						35	10	3,30	M8	-	23,41 €
PCS50-27H-38K						38	10	3,30	M8	-	23,41 €
PCS50-30H-25K	30	121,50	126,00	80	30	25	8	3,30	M6	-	27,09 €
PCS50-30H-28K						28	8	3,30	M6	-	27,09 €
PCS50-30H-30K						30	8	3,30	M6	✓	27,09 €
PCS50-30H-32K						32	10	3,30	M8	-	27,09 €
PCS50-30H-35K						35	10	3,30	M8	-	27,09 €
PCS50-30H-38K						38	10	3,30	M8	-	27,09 €

*Dans la limite du disponible - Dimensions en mm

Pignon à chaîne alésé rainuré



DIN10B-1 Acier traité C45, denture trempée

5/8"



- Pas 15,875mm (DIN 10B-1)
- Diam. rouleau 10,16mm
- Matière :
Acier C45 UNI7845
Denture trempée 45-53HRC

Info

- Rainure de clavette selon DIN6885 dans l'axe d'une dent
- 2 trous taraudés à 90°

Accessoire

- Chaîne SBR-625/M (tome 4 p.122)

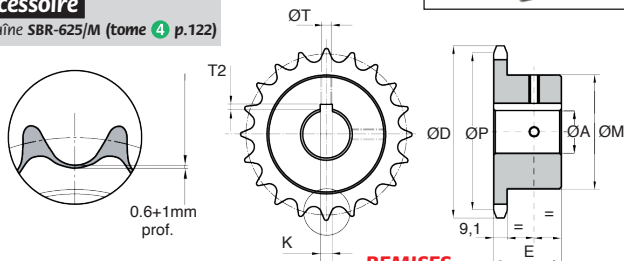
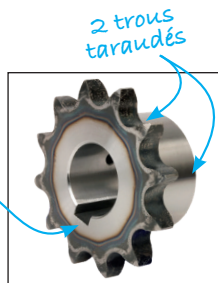

REMISES

Qté	1+	6+	20+	40+
Rem.	Prix -12% -25% Sur demande			

Références	Z Dents	ØP	ØD	ØM	E	ØA	K (H9)	T2	ØT	Prix Uni. 1 à 5					
PCS62-12H-16K	12	61,34	68,20	42	30	16	5	2,30	M4	12,82 €					
PCS62-12H-19K						19	6	2,80	M5	12,82 €					
PCS62-12H-20K						20	6	2,80	M5	12,82 €					
PCS62-12H-22K						22	6	2,80	M5	12,82 €					
PCS62-12H-24K						24	8	3,30	M6	12,82 €					
PCS62-12H-25K						25	8	3,30	M6	12,82 €					
PCS62-12H-28K						51	30	28	8	3,30	M6	12,82 €			
PCS62-12H-30K						51	30	30	8	3,30	M6	12,82 €			
PCS62-13H-16K						13	66,32	73,20	47	30	16	5	2,30	M4	13,17 €
PCS62-13H-19K											19	6	2,80	M5	13,17 €
PCS62-13H-20K	20	6	2,80	M5	13,17 €										
PCS62-13H-22K	22	6	2,80	M5	13,17 €										
PCS62-13H-24K	24	8	3,30	M6	13,17 €										
PCS62-13H-25K	25	8	3,30	M6	13,17 €										
PCS62-13H-28K	28	8	3,30	M6	13,17 €										
PCS62-13H-30K	30	8	3,30	M6	13,17 €										

Dimensions en mm

REMISES

Qté	1+	6+	20+	40+
Rem.	Prix	-12%	-25%	Sur demande

Références	Z	Dents	ØP	ØD	ØM	E	ØA	K (H9)	T2	ØT	Prix Uni. 1 à 5
PCS62-14H-16K							16	5	2,30	M4	14,33 €
PCS62-14H-19K							19	6	2,80	M5	14,33 €
PCS62-14H-20K							20	6	2,80	M5	14,33 €
PCS62-14H-22K							22	6	2,80	M5	14,33 €
PCS62-14H-24K	14	71,34	78,20	52	30		24	8	3,30	M6	14,33 €
PCS62-14H-25K							25	8	3,30	M6	14,33 €
PCS62-14H-28K							28	8	3,30	M6	14,33 €
PCS62-14H-30K							30	8	3,30	M6	14,33 €
PCS62-15H-19K							19	6	2,80	M5	16,12 €
PCS62-15H-20K							20	6	2,80	M5	16,12 €
PCS62-15H-22K							22	6	2,80	M5	16,12 €
PCS62-15H-24K							24	8	3,30	M6	16,12 €
PCS62-15H-25K	15	76,36	83,20	57	30		25	8	3,30	M6	16,12 €
PCS62-15H-28K							28	8	3,30	M6	16,12 €
PCS62-15H-30K							30	8	3,30	M6	16,12 €
PCS62-15H-32K							32	10	3,30	M8	16,12 €
PCS62-15H-35K							35	10	3,30	M8	16,12 €
PCS62-16H-20K							20	6	2,80	M5	17,39 €
PCS62-16H-22K							22	6	2,80	M5	17,39 €
PCS62-16H-24K							24	8	3,30	M6	17,39 €
PCS62-16H-25K	16	81,37	88,00	60	30		25	8	3,30	M6	17,39 €
PCS62-16H-28K							28	8	3,30	M6	17,39 €
PCS62-16H-30K							30	8	3,30	M6	17,39 €
PCS62-16H-32K							32	10	3,30	M8	17,39 €
PCS62-16H-35K							35	10	3,30	M8	17,39 €
PCS62-17H-20K							20	6	2,80	M5	18,25 €
PCS62-17H-22K							22	6	2,80	M5	18,25 €
PCS62-17H-24K							24	8	3,30	M6	18,25 €
PCS62-17H-25K	17	86,39	93,20	60	30		25	8	3,30	M6	18,25 €
PCS62-17H-28K							28	8	3,30	M6	18,25 €
PCS62-17H-30K							30	8	3,30	M6	18,25 €
PCS62-17H-32K							32	10	3,30	M8	18,25 €
PCS62-17H-35K							35	10	3,30	M8	18,25 €
PCS62-18H-20K							20	6	2,80	M5	20,39 €
PCS62-18H-22K							22	6	2,80	M5	20,39 €
PCS62-18H-24K							24	8	3,30	M6	20,39 €
PCS62-18H-25K							25	8	3,30	M6	20,39 €
PCS62-18H-28K	18	91,42	98,30	70	30		28	8	3,30	M6	20,39 €
PCS62-18H-30K							30	8	3,30	M6	20,39 €
PCS62-18H-32K							32	10	3,30	M8	20,39 €
PCS62-18H-35K							35	10	3,30	M8	20,39 €
PCS62-18H-38K							38	10	3,30	M8	20,39 €
PCS62-18H-40K							40	12	3,30	M10	20,39 €

Dimensions en mm

Pignon à chaîne alésé rainuré

Aci **DIN**

DIN10B-1 Acier traité C45, denture trempée

5/8"



- Pas 15,875mm (DIN 10B-1)
- Diam. rouleau 10,16mm
- Matière :
Acier C45 UNI7845
Denture trempée 45-53HRC

Info

- Rainure de clavette selon DIN6885 dans l'axe d'une dent
- 2 trous taraudés à 90°

Accessoire

- Chaîne SBR-625/M (tome 4 p.122)

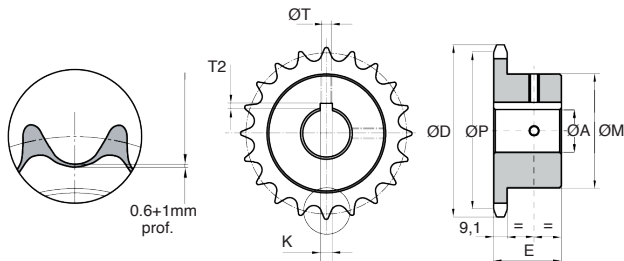
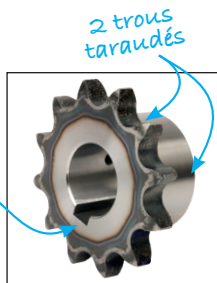

REMISES

Qté	1+	6+	20+	40+
Rem.	Prix	-12%	-25%	Sur demande

Références	Z	Dents	ØP	ØD	ØM	E	ØA	K (H9)	T2	ØT	Prix Uni. 1 à 5
PCS62-19H-20K							20	6	2,80	M5	22,01 €
PCS62-19H-22K							22	6	2,80	M5	22,01 €
PCS62-19H-24K							24	8	3,30	M6	22,01 €
PCS62-19H-25K							25	8	3,30	M6	22,01 €
PCS62-19H-28K							28	8	3,30	M6	22,01 €
PCS62-19H-30K	19	96,45	103,30	70	30		30	8	3,30	M6	22,01 €
PCS62-19H-32K							32	10	3,30	M8	22,01 €
PCS62-19H-35K							35	10	3,30	M8	22,01 €
PCS62-19H-38K							38	10	3,30	M8	22,01 €
PCS62-19H-40K							40	12	3,30	M10	22,01 €

Dimensions en mm

Références	Z	Dents	ØP	ØD	ØM	E	ØA	K (H9)	T2	ØT	Prix Uni. 1 à 5
PCS62-20H-20K	20	101,49	108,40	75	30	20	6	2,80	M5	23,20 €	
PCS62-20H-22K						22	6	2,80	M5	23,20 €	
PCS62-20H-24K						24	8	3,30	M6	23,20 €	
PCS62-20H-25K						25	8	3,30	M6	23,20 €	
PCS62-20H-28K						28	8	3,30	M6	23,20 €	
PCS62-20H-30K						30	8	3,30	M6	23,20 €	
PCS62-20H-32K						32	10	3,30	M8	23,20 €	
PCS62-20H-35K						35	10	3,30	M8	23,20 €	
PCS62-20H-38K						38	10	3,30	M8	23,20 €	
PCS62-20H-40K						40	12	3,30	M10	23,20 €	
PCS62-21H-20K	21	106,52	113,40	75	30	20	6	2,80	M5	24,57 €	
PCS62-21H-22K						22	6	2,80	M5	24,57 €	
PCS62-21H-24K						24	8	3,30	M6	24,57 €	
PCS62-21H-25K						25	8	3,30	M6	24,57 €	
PCS62-21H-28K						28	8	3,30	M6	24,57 €	
PCS62-21H-30K						30	8	3,30	M6	24,57 €	
PCS62-21H-32K						32	10	3,30	M8	24,57 €	
PCS62-21H-35K						35	10	3,30	M8	24,57 €	
PCS62-21H-38K						38	10	3,30	M8	24,57 €	
PCS62-21H-40K						40	12	3,30	M10	24,57 €	
PCS62-23H-20K	23	116,58	123,40	80	30	20	6	2,80	M5	26,78 €	
PCS62-23H-22K						22	6	2,80	M5	26,78 €	
PCS62-23H-24K						24	8	3,30	M6	26,78 €	
PCS62-23H-25K						25	8	3,30	M6	26,78 €	
PCS62-23H-28K						28	8	3,30	M6	26,78 €	
PCS62-23H-30K						30	8	3,30	M6	26,78 €	
PCS62-23H-32K						32	10	3,30	M8	26,78 €	
PCS62-23H-35K						35	10	3,30	M8	26,78 €	
PCS62-23H-38K						38	10	3,30	M8	26,78 €	
PCS62-23H-40K						40	12	3,30	M10	26,78 €	
PCS62-23H-42K	42	12	3,30	M10	26,78 €						
PCS62-24H-20K	24	121,62	128,50	80	30	20	6	2,80	M5	28,21 €	
PCS62-24H-22K						22	6	2,80	M5	28,21 €	
PCS62-24H-24K						24	8	3,30	M6	28,21 €	
PCS62-24H-25K						25	8	3,30	M6	28,21 €	
PCS62-24H-28K						28	8	3,30	M6	28,21 €	
PCS62-24H-30K						30	8	3,30	M6	28,21 €	
PCS62-24H-32K						32	10	3,30	M8	28,21 €	
PCS62-24H-35K						35	10	3,30	M8	28,21 €	
PCS62-24H-38K						38	10	3,30	M8	28,21 €	
PCS62-24H-40K						40	12	3,30	M10	28,21 €	
PCS62-24H-42K	42	12	3,30	M10	28,21 €						
PCS62-25H-22K	25	126,66	133,50	80	30	22	6	2,80	M5	29,15 €	
PCS62-25H-24K						24	8	3,30	M6	29,15 €	
PCS62-25H-25K						25	8	3,30	M6	29,15 €	
PCS62-25H-28K						28	8	3,30	M6	29,15 €	
PCS62-25H-30K						30	8	3,30	M6	29,15 €	
PCS62-25H-32K						32	10	3,30	M8	29,15 €	
PCS62-25H-35K						35	10	3,30	M8	29,15 €	
PCS62-25H-38K						38	10	3,30	M8	29,15 €	
PCS62-25H-40K						40	12	3,30	M10	29,15 €	
PCS62-25H-42K						42	12	3,30	M10	29,15 €	

Dimensions en mm

Pignon à chaîne alésé rainuré



DIN12B-1 Acier traité C45, denture trempée

3/4"



2 trous taraudés

- Pas 19,05mm (DIN 12B-1)
- Diam. rouleau 12,07mm
- Matière :
Acier C45 UNI7845
Denture trempée 45-53HRC

Alésage et rainure de clavette

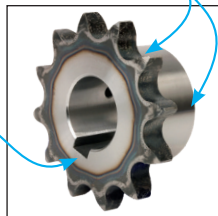

Info

- Rainure de clavette selon DIN6885 dans l'axe d'une dent
- 2 trous taraudés à 90°

Accessoire

- Chaîne SBR-750/M (tome 4 p.122)

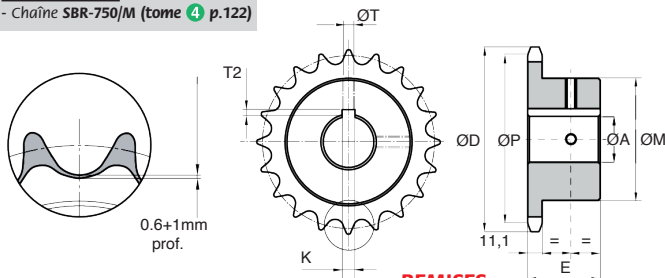

REMISES

Qté	1+	6+	20+	40+
Rem.	Prix	-12%	-25%	Sur demande

Références	Z Dents	ØP	ØD	ØM	E	ØA	K (H9)	T2	ØT	Prix Uni. 1 à 5					
PCS75-12H-20K	12	73,60	81,80	52	35	20	6	2,80	M5	16,67 €					
PCS75-12H-22K						22	6	2,80	M5	16,67 €					
PCS75-12H-24K						24	8	3,30	M6	16,67 €					
PCS75-12H-25K						25	8	3,30	M6	16,67 €					
PCS75-12H-28K						28	8	3,30	M6	16,67 €					
PCS75-12H-30K						30	8	3,30	M6	16,67 €					
PCS75-13H-20K						13	79,60	87,10	58	35	20	6	2,80	M5	19,31 €
PCS75-13H-22K											22	6	2,80	M5	19,31 €
PCS75-13H-24K											24	8	3,30	M6	19,31 €
PCS75-13H-25K											25	8	3,30	M6	19,31 €
PCS75-13H-28K	28	8	3,30	M6	19,31 €										
PCS75-13H-30K	30	8	3,30	M6	19,31 €										
PCS75-13H-32K	32	10	3,30	M8	19,31 €										
PCS75-13H-35K	35	10	3,30	M8	19,31 €										

Dimensions en mm

REMISES

Qté	1+	6+	20+	40+
Rem.	Prix	-12%	-25%	Sur demande

Références	Z					K				Prix Uni. 1 à 5
	Dents	ØP	ØD	ØM	E	ØA	(H9)	T2	ØT	
PCS75-14H-20K						20	6	2,80	M5	22,00 €
PCS75-14H-22K						22	6	2,80	M5	22,00 €
PCS75-14H-24K						24	8	3,30	M6	22,00 €
PCS75-14H-25K	14	85,61	93,80	64	35	25	8	3,30	M6	22,00 €
PCS75-14H-28K						28	8	3,30	M6	22,00 €
PCS75-14H-30K						30	8	3,30	M6	22,00 €
PCS75-14H-32K						32	10	3,30	M8	22,00 €
PCS75-14H-35K						35	10	3,30	M8	22,00 €
PCS75-15H-20K										
PCS75-15H-22K						22	6	2,80	M5	24,00 €
PCS75-15H-24K						24	8	3,30	M6	24,00 €
PCS75-15H-25K	15	91,63	99,20	70	35	25	8	3,30	M6	24,00 €
PCS75-15H-28K						28	8	3,30	M6	24,00 €
PCS75-15H-30K						30	8	3,30	M6	24,00 €
PCS75-15H-32K						32	10	3,30	M8	24,00 €
PCS75-15H-35K						35	10	3,30	M8	24,00 €
PCS75-15H-38K						38	10	3,30	M8	24,00 €
PCS75-15H-40K						40	12	3,30	M10	24,00 €
PCS75-16H-20K						20	6	2,80	M5	25,64 €
PCS75-16H-22K						22	6	2,80	M5	25,64 €
PCS75-16H-24K						24	8	3,30	M6	28,00 €
PCS75-16H-25K	16	97,65	105,50	75	35	25	8	3,30	M6	25,64 €
PCS75-16H-28K						28	8	3,30	M6	25,64 €
PCS75-16H-30K						30	8	3,30	M6	25,64 €
PCS75-16H-32K						32	10	3,30	M8	25,64 €
PCS75-16H-35K						35	10	3,30	M8	25,64 €
PCS75-16H-38K						38	10	3,30	M8	25,64 €
PCS75-16H-40K						40	12	3,30	M10	25,64 €
PCS75-17H-22K						22	6	2,80	M5	27,50 €
PCS75-17H-24K						24	8	3,30	M6	30,14 €
PCS75-17H-25K						25	8	3,30	M6	27,50 €
PCS75-17H-28K	17	103,67	111,20	80	35	28	8	3,30	M6	27,50 €
PCS75-17H-30K						30	8	3,30	M6	27,50 €
PCS75-17H-32K						32	10	3,30	M8	27,50 €
PCS75-17H-35K						35	10	3,30	M8	27,50 €
PCS75-17H-38K						38	10	3,30	M8	27,50 €
PCS75-17H-40K						40	12	3,30	M10	27,50 €
PCS75-18H-22K						22	6	2,80	M5	28,28 €
PCS75-18H-24K						24	8	3,30	M6	31,05 €
PCS75-18H-25K	18	109,71	118,00	80	35	25	8	3,30	M6	28,28 €
PCS75-18H-28K						28	8	3,30	M6	28,28 €
PCS75-18H-30K						30	8	3,30	M6	28,28 €
PCS75-18H-32K						32	10	3,30	M8	28,28 €
PCS75-18H-35K						35	10	3,30	M8	28,28 €
PCS75-18H-38K						38	10	3,30	M8	28,28 €
PCS75-18H-40K						40	12	3,30	M10	28,28 €

Dimensions en mm

Pignon à chaîne alésé rainuré



DIN12B-1 Acier traité C45, denture trempée

3/4"



- Pas 19,05mm (DIN 12B-1)
- Diam. rouleau 12,07mm
- Matière :
Acier C45 UNI7845
Denture trempée 45-53HRC

Info

- Rainure de clavette selon DIN6885 dans l'axe d'une dent
- 2 trous taraudés à 90°

Accessoire

- Chaîne SBR-750/M (tome 4 p.122)

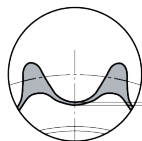
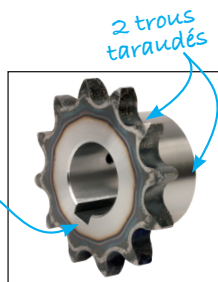

0.6+1mm
prof.

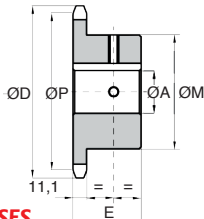
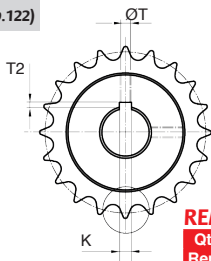

REMISES

Qté	1+	6+	20+	40+
Rem.	Prix	-12%	-25%	Sur demande

Références	Z Dents	ØP	ØD	ØM	E	ØA	K (H9)	T2	ØT	Prix Uni. 1 à 5
PCS75-19H-25K	19	115,75	123,30	80	35	25	8	3,30	M6	30,89 €
PCS75-19H-28K						28	8	3,30	M6	30,89 €
PCS75-19H-30K						30	8	3,30	M6	30,89 €
PCS75-19H-32K						32	10	3,30	M8	30,89 €
PCS75-19H-35K						35	10	3,30	M8	30,89 €
PCS75-19H-38K						38	10	3,30	M8	30,89 €
PCS75-19H-40K						40	12	3,30	M10	30,89 €
PCS75-19H-42K						42	12	3,30	M10	30,89 €
PCS75-19H-45K						45	14	3,80	M12	30,89 €
PCS75-20H-25K						20	121,78	129,70	80	35
PCS75-20H-28K	28	8	3,30	M6	32,68 €					
PCS75-20H-30K	30	8	3,30	M6	32,68 €					
PCS75-20H-32K	32	10	3,30	M8	32,68 €					
PCS75-20H-35K	35	10	3,30	M8	32,68 €					
PCS75-20H-38K	38	10	3,30	M8	32,68 €					
PCS75-20H-40K	40	12	3,30	M10	32,68 €					
PCS75-20H-42K	42	12	3,30	M10	32,68 €					
PCS75-20H-45K	45	14	3,80	M12	32,68 €					

Dimensions en mm

REMISES

Qté	1+	6+	20+	40+
Rem.	Prix	-12%	-25%	Sur demande

Références	Z	Dents	ØP	ØD	ØM	E	ØA	K (H9)	T2	ØT	Prix Uni. 1 à 5
PCS75-21H-28K	21	127,82	135,40	90	40	28	8	3,30	M6	38,65 €	
PCS75-21H-30K						30	8	3,30	M6	38,65 €	
PCS75-21H-32K						32	10	3,30	M8	38,65 €	
PCS75-21H-35K						35	10	3,30	M8	38,65 €	
PCS75-21H-38K						38	10	3,30	M8	38,65 €	
PCS75-21H-40K						40	12	3,30	M10	38,65 €	
PCS75-21H-42K						42	12	3,30	M10	38,65 €	
PCS75-21H-45K						45	14	3,80	M12	38,65 €	
PCS75-21H-48K						48	14	3,80	M12	38,65 €	
PCS75-21H-50K						50	14	3,80	M12	38,65 €	
PCS75-23H-28K	23	139,90	147,40	90	40	28	8	3,30	M6	44,15 €	
PCS75-23H-30K						30	8	3,30	M6	44,15 €	
PCS75-23H-32K						32	10	3,30	M8	44,15 €	
PCS75-23H-35K						35	10	3,30	M8	44,15 €	
PCS75-23H-38K						38	10	3,30	M8	44,15 €	
PCS75-23H-40K						40	12	3,30	M10	44,15 €	
PCS75-23H-42K						42	12	3,30	M10	44,15 €	
PCS75-23H-45K						45	14	3,80	M12	44,15 €	
PCS75-23H-48K						48	14	3,80	M12	44,15 €	
PCS75-23H-50K						50	14	3,80	M12	44,15 €	
PCS75-24H-28K	24	145,94	154,10	90	40	28	8	3,30	M6	44,76 €	
PCS75-24H-30K						30	8	3,30	M6	44,76 €	
PCS75-24H-32K						32	10	3,30	M8	44,76 €	
PCS75-24H-35K						35	10	3,30	M8	44,76 €	
PCS75-24H-38K						38	10	3,30	M8	44,76 €	
PCS75-24H-40K						40	12	3,30	M10	44,76 €	
PCS75-24H-42K						42	12	3,30	M10	44,76 €	
PCS75-24H-45K						45	14	3,80	M12	44,76 €	
PCS75-24H-48K						48	14	3,80	M12	44,76 €	
PCS75-24H-50K						50	14	3,80	M12	44,76 €	
PCS75-25H-28K	25	152,00	159,50	90	40	28	8	3,30	M6	47,53 €	
PCS75-25H-30K						30	8	3,30	M6	47,53 €	
PCS75-25H-32K						32	10	3,30	M8	47,53 €	
PCS75-25H-35K						35	10	3,30	M8	47,53 €	
PCS75-25H-38K						38	10	3,30	M8	47,53 €	
PCS75-25H-40K						40	12	3,30	M10	47,53 €	
PCS75-25H-42K						42	12	3,30	M10	47,53 €	
PCS75-25H-45K						45	14	3,80	M12	47,53 €	
PCS75-25H-48K						48	14	3,80	M12	47,53 €	
PCS75-25H-50K						50	14	3,80	M12	47,53 €	

Dimensions en mm